



HAL
open science

Intuitiveness facilitates Rehabilitation: Clinical results

Ludovic Saint-Bauzel, Viviane Pasqui

► **To cite this version:**

Ludovic Saint-Bauzel, Viviane Pasqui. Intuitiveness facilitates Rehabilitation: Clinical results. IEEE International Conference on Rehabilitation Robotics, Jun 2009, Kyoto, Japan. 10.1109/ICORR.2009.5209545 . hal-01170408

HAL Id: hal-01170408

<https://hal.sorbonne-universite.fr/hal-01170408>

Submitted on 2 Jul 2015

HAL is a multi-disciplinary open access archive for the deposit and dissemination of scientific research documents, whether they are published or not. The documents may come from teaching and research institutions in France or abroad, or from public or private research centers.

L'archive ouverte pluridisciplinaire **HAL**, est destinée au dépôt et à la diffusion de documents scientifiques de niveau recherche, publiés ou non, émanant des établissements d'enseignement et de recherche français ou étrangers, des laboratoires publics ou privés.

Intuitiveness facilitates Rehabilitation: Clinical results

Ludovic Saint-Bauzel *, Viviane Pasqui* and Isabelle Monteil†

* ISIR, e-mail: saintbauzel@isir.fr, pasqui@isir.fr, UPMC-Paris6, France

† e-mail: imonteil-roch@centresainte-marie.com, Hospital "Centre Sainte-Marie", Paris, France

Abstract—This article presents how an adapted design of a mechatronics system and its control can lead to an intuitive interface for patients performing sit-to-stand motions. We focus on the design of a control based on fuzzy rules obtained by an analysis of external interaction forces subjects during motion. Experiments are done with 10 diseased patients in Bellan hospital and show a good learning rate.

I. INTRODUCTION

Rehabilitation involves the management of disorders that alter the motor abilities and performance of patients. In essence, it is a combination of medication, physical manipulation, therapeutic exercises and adaptation to technical aids. In the case of rehabilitation for locomotion, physiotherapists must manage postural balance. Without technical aids, several persons are needed to maintain quite at the same time the patient in standing up posture and make him/her do therapeutic movements. This supplementary task is difficult and does not require any medical skills (see figure 1, left).



Fig. 1. Classical gait rehabilitation [1]

In addition, postures needed to apply these exercises to a patient are uncomfortable for medical staff (see figure 1, right). Consequently, exercises are short in time, a further limitation to the rehabilitation protocols.

Finally, the more time the medical staff spends with a patient, the better the patient is healed but less patients are healed.

Recently, technological aids and robots have been introduced to reduce the number of persons around the patient.

Indeed, robotic systems could be an asset and may be used to:

- Reduce the load of the medical staff
- Make some repetitive basic movements
- Assist the patient in therapeutic movements

- Guide movements to be as natural as possible
- Keep control of therapeutic movements
- Develop new rehabilitation protocols
- Bring an evaluation thanks to robot sensors acquisition

For these advantages, many rehabilitation robotic devices are proposed. Obviously a robotized interface for rehabilitation has to be adapted to the kind of pathologies addressed to assist the patient and to make him/her "work" to reduce effects of his/her disease.

In some pathologies (multi-sclerosis, post-fall syndrome, etc.), recovery of the locomotion is possible if someone walks with the patient. These pathologies affect postural balance and consequently lead to many difficulties during both sit-to-stand transfer and walking actions. In these cases, it is necessary to support the balance. And this support can be a first requirement to involve rehabilitation. In these conditions, it is important to choose a solution that can be used in daily life and that is able to help the patient during gait and sit-to-stand. Currently, when the locomotion exists but is deficient, the most used technical aid is the zimmer frame. Such a mechanical system, improved by advanced robotics techniques in order to reinforce walking in safe conditions, could address many diseases or deficiencies.

Concerning rehabilitation of lower limbs, the most common exercises are addressing locomotor system training. These exercises are used to train upright posture and walking movement and they often aim paraplegia patients.

The robotized solutions for those exercises consist in one hand of a body harness supporting the patient's weight and on the other hand of a robotized interface in contact with lower limbs to make him/her walk.

A first kind of such solutions is based on an exoskeleton structure, existing solutions are Lokomat [2], and also AutoAmbulator [3] or PAM/POGO [4]. They are mechanically designed to follow many parts of the body. They bring some asset in guiding. The walking is trained but exoskeleton solutions need too much power to be embedded so that the patient is walking on a treadmill and his motion is guided by the robot. This solution is safe but can only be used in a clinical environment. For the same reason, a device like HapticWalker [5] that is totally different in its design is not suitable. It can only move the feet of the patient. Its mechanical design is based on an analysis of operational space of the feet considered as end effectors that the robot must be able to follow. A weight support is included in the system and it is able to propose some motions of daily

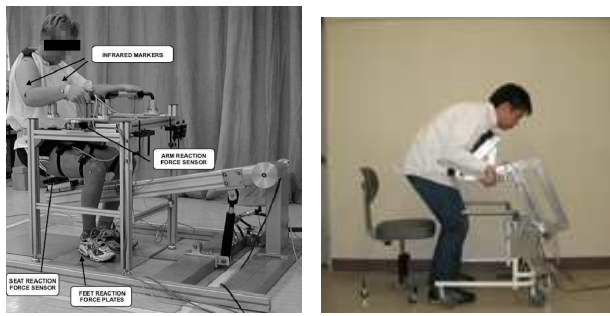

(a) FES Supported sit-to-stand rehabilitation robot (b) Standing Assistance System

Fig. 2. Sit-to-stand robotized solutions

life like climbing stairs, walking... Those solutions are real clinical aid but due to their great size, they are not suitable for a daily home training. So they are more used for patient that need to recover basic movements. Their lack of mobility does not permit to make daily home reinforcement rehabilitation exercises.

Adapted robotized interfaces like KineAssist [6] or WHERE [7] can help patients that need to walk and to have a weighty support. However, when the patient is still strong enough to support his/her body, it is not suitable to use a harness, that can lead to a loose of muscular strength.

If we address sit-to-stand motion, Kamnick and Bajd [8] propose a rehabilitation robotized solution, that is composed of a robotized chair and a force sensor instrumented handrail (fig. 2(a)). This solution is not mobile so it can only be used in clinical environment. The "Standing Assistant System" proposed by Chugo [9], is mobile so it may be a solution for daily life. However the current prototype is designed on a free wheel mobile platform (see fig.2(b)) so this prototype is limited to problems with sit-to-stand motion. It supposes that disbalance during gait could be resolved by a zimmer frame.

The kind of suitable robotics solution designs able to bring an asset to life of patient that we address in this paper are coming from research that are dedicated to rehabilitation and to assist gait for elderly as: Care-O-Bot [10], Guido [11], Walker RT [12] or MONIMAD [13] which are presented in figure 3. The last robot (MONIMAD) is designed and used in the experiments presented here.

The MONIMAD prototype is initially designed to support elderly patients affected by post-fall syndrome [14]. To fit these needs, the main idea is to get inspired by the functionalities of a zimmer frame, improved by contribution of advanced robotics techniques.

The robotic device presented in this paper is an active mobile base platform with actioned articulated arms and driven by a whole sensors based control. That control, detailed in this paper, is a reactive control able to identify voluntary movements. Our goal is that the person feels helped by the system rather than driven or guided by a machine.

A particularity of this work is that it is centered on helping people. The patient is not considered in the control as a

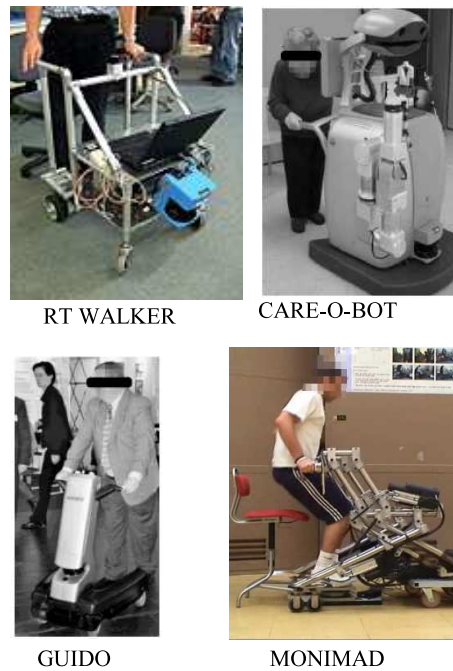

Fig. 3. Robotic walker aids

master nor as a slave of the robot. Patients do exercises with the robot in a way that the support of the machine feels transparent.

This aim is achieved by the use of a fuzzy-logic based control that works from an immediate and natural handling of the robot, not a control based on a box with buttons or particular gesture to control the device. Furthermore, assistance must begin from the sit gesture, with as few preparation as possible to use the robotized interface.

The MONIMAD prototype (see figure 4) is evaluated in a rehabilitation hospital specialized in the case of multi-sclerosis diseased patients who are often affected by cerebellar ataxia, a disease that leads to trouble in balance during sit-to-stand and walking gestures.

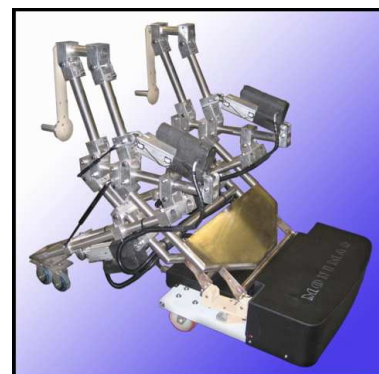

Fig. 4. The MONIMAD Prototype

The aim of this paper is to present experiments with MONIMAD used by patient to stand-up, and to study the

learning rate of the device. Section II explains the mechanical structure of the MONIMAD prototype and the implemented control that brings reactivity to the robot. In section III, we describe the experimental protocol worked out by the medical staff. Then, section IV is dedicated to the discussion on the pros and cons of both our method and our experiments.

II. MATERIAL AND METHODS

The aim of the MONIMAD prototype is to help people without human assistance. This work is driven by the Physical Human-robot Interaction in mechanical design and in control design.

A. Mechanical design

The detailed mechanical design method is described in [15]. The main idea of the design is to place natural actions addressed above as the main requirement. The designed robotic system is basically a two degrees of freedom (dof) arm mechanism mounted on an active mobile platform. Its kinematics is described in Fig. 5.

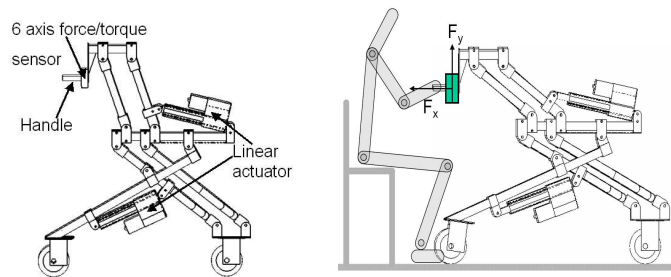

Fig. 5. Description of the robotized interface

For the sit-to-stand transfer, handles must first pull slowly the patient to an antepulsion configuration. Then, the handles go from its down to its up position, used for walking. Obviously, the handles must remain horizontal during the whole transition. This is obtained by a serial combination of two 1 dof closed loop mechanisms. The upper part of the mechanism is constituted by two simple parallelograms: the arms and the lower part is equivalent to a Scott-Russel mechanism [16].

The arms are independent in order to restore lateral balance when the user begins to lose it, this functionality is not presented in this paper. The wheelbase length is variable: it is longer to increase stability during the sit-to-stand transfer and shorter during walking for facilitate ambulation. In addition, handles are equipped with six components forces sensors which are used to make the whole mechanism transparent to the user (i.e. for Physical Human-Robot Interaction).

Measurement are done on sit-to-stand transfer. The chosen force range are based on the measured forces of the support platform that help people to stand-up. These forces are lower than the weight of the patient. The robot is not designed to replace the patient motion but to bring some force to support him/her during his/her own motion.

B. Control design

In this section, we explain how an adapted control can give intuitive ability to this robotic interface. By intuitiveness, we mean the capacity to interpret the postural movements detected by the sensors to trigger the movement or to maintain postural balance.

In a normal sit-to-stand scene, the patient puts his weight on the robot handles, rises up from the chair and walks. But many others cases can appear in the scene such as: the patient cannot rise from the chair and wants to seat back or when he is nearly standing up, he loses balance, etc.

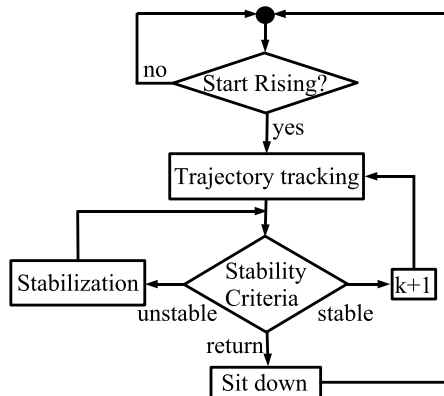

Fig. 6. A sit-to-stand scenario schema

The different ways to detect these abnormal cases and the corresponding robot reactions are presented in Fig. 6. The detection of these abnormalities is based on human postural analysis, thus the different reactions of the robot are control laws and the overall schema is managed by a fuzzy supervisor.

C. Abnormality detection

To observe the postural state, experimental dynamical analysis of the stand-up gesture has been performed in our laboratory [17]. To record postural data, subjects are instrumented with goniometers placed on the leg articulations (hip, knee, ankle) and accelerometers placed on the breast. We have also used an instrumented handle equipped of a 6 axis force sensor and a localization sensor (MiniBird). In addition, the subject's feet are placed on a 6 axis force sensor.

Subjects are 10 healthy people of 25 years in average, weighting 70 kg. They are start from a chair. They are asked to hold the instrumented handle and to try to stand-up. Subjects were invited to achieve two gestures:

- 10 natural speed sit-to-stand,
- 10 high speed sit-to-stand (as fast as they can without losing contact with the ground).

In order not to exhaust the subjects, they are advised to make a long time pause between each movement.

Three main sit-to-stand phases are represented in Fig. 7(a). These phases are: pre-acceleration, acceleration and rising. Each phase depends on interaction forces between

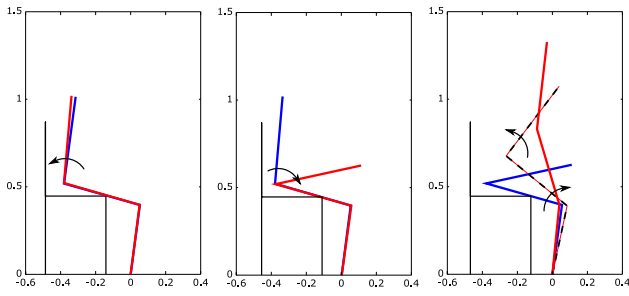

(a) 3 phases of sit-to-stand movement

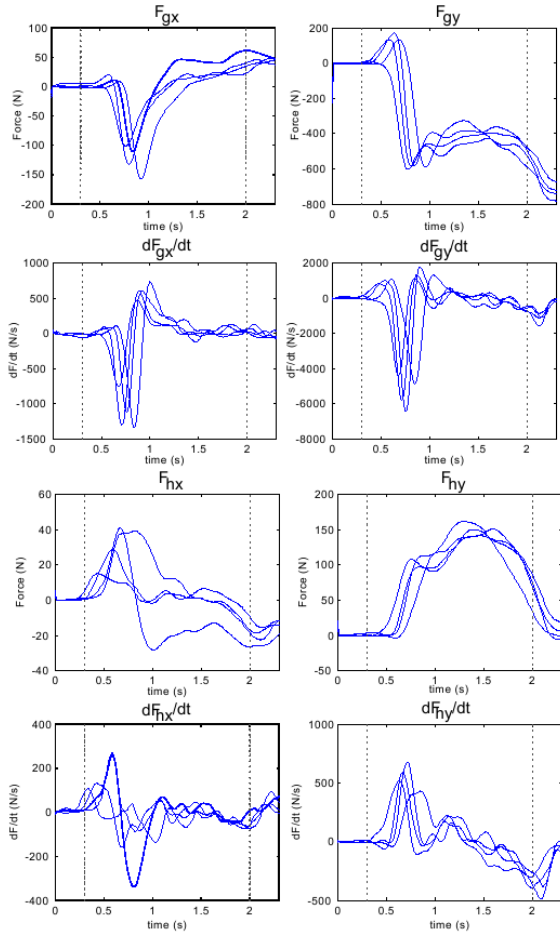

(b) Forces Recorded and their derivatives

Fig. 7. Different sit-to-stand phases analysis

the subject and the handles: $\vec{F}_h = (F_{hx}, F_{hy})$, the subject and the ground: $\vec{F}_g = (F_{gx}, F_{gy})$ and their time variations. The Center of Pressure (CoP) which position may be used as a stability criterion [18] is computed from the reaction force.

Observation of the CoP position and direction of the force \vec{F}_h yields simple rules to identify instability cases or desired movement to trigger (i.e. beginning of the sit-to-stand).

Detection of unstable posture is illustrated in Fig. 8, where both patient and robot are modeled by a 3 links model each. The difference between both models lies in the interaction

with the ground. We assume that the robotic interface cannot loose contact with the ground while the subject could if he or she is unstable.

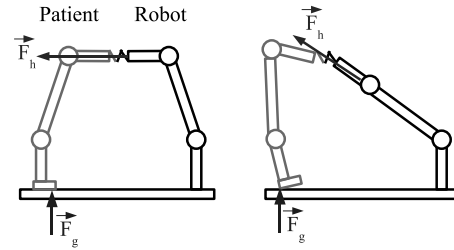

Fig. 8. Interaction between patient and robotic interface

If a subject, under perturbations, is about to loose balance, he or she quickly shifts the load within the foot support area in the opposite direction with respect to the fall direction (Fig.8. left). If the perturbation is too high or if the fall is impending, the CoP will rapidly move in the direction of fall until it reaches the limit of the sustentation area (Fig. 8, right).

D. Robot reactions as control laws

The control is based on different states of the patient that are involving different states of the robot. These states are in a higher level than states used in state based control. So one can call these states ‘‘Control Modes’’. The control modes implemented in this paper are:

- 1) **Normal:** The assistive device handles guide the patient to rise from a chair or to sit down, following trajectories that are based on parameters reflecting personal strategies [19].
- 2) **Impedance:** To define his or her personal trajectory, the patient must choose the high and the low positions of the handles. To choose these positions, a nurse helps the user to stand-up and the assistive device is in a transparent mode (i.e. the force applied to patient are controlled to be equal to zero).
- 3) **Stabilization:** The handlers stop moving and pull/push the hand in the opposite direction w.r.t. the started fall. Then, the tracking trajectory is modified to stabilize the patient.
- 4) **Return:** The interface returns to the initial position following a specific trajectory defined in [19].

Those control modes are decided to fit with sit-to-stand motion but one could extend the approach to other modes in different rehabilitation contexts.

All these control modes are designed with fuzzy logic blocks that identify the postural state of the patient, and put the robot into the corresponding control mode.

E. Fuzzy supervisor

A fuzzy controller is a good way to design an interactive device [20],[21]. Here, we have extended the role of the fuzzy supervisor from the detection of voluntary movements to the detection of instability.

From the set of experimental data, fuzzy logic sets are tuned to have a representative definition of supervisor. The fuzzy supervision has to fulfill two tasks, that define two output:

- **output 1:** recognition of the current phase, resulting in the choice of control modes 1, 2, 4
- **output 2:** determination of the proper reaction to ensure stability of the subject, and determine amount of use of control mode 3.

The fuzzy sets defined for the output 1 are shown in Fig.9.

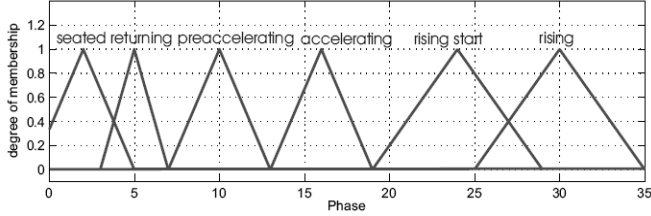

Fig. 9. Membership functions for output 1

The detection of the phases of the sit-to-stand is obtained analyzing the value of the \vec{F}_h, \vec{F}_g forces, their time variation and CoP.

A fuzzy-controller able to represent sit-to-stand transfer is set-up from force information obtained at the handle, force information coming from the ground interaction and computation of the CoP.

The membership functions for the output 2 are shown in Fig. 10, they determine the movement for a detected phase. The following fuzzy sets are then defined:

- **unstable:** object underlies high unbalance. Quick reaction is required.
- **stabilize:** object indicates desire of stabilization.
- **no move:** no movement is necessary in the horizontal direction.
- **adjust:** object desires another position of the handles.

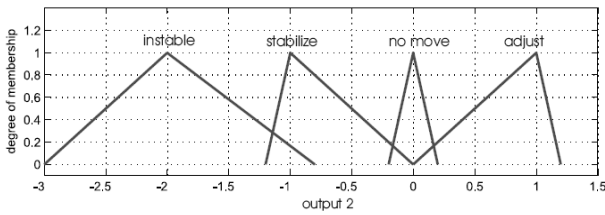

Fig. 10. Membership functions for output 2

If we denote high with 'H', zero with 'Z', low with 'L', extremely low with 'EL' and extremely high with 'EH', it is possible to explain every control mode with a fuzzy rule. As an example here is the case of RISING state:

IF $F_{gy}=EL$ AND $F_{hx}=L$ AND $\frac{dF_{hy}}{dt}=H$
THEN the human is RISING.

The complete controller structure is shown in Figure 11. A more detailed explanation of implemented fuzzy rules is done in [22].

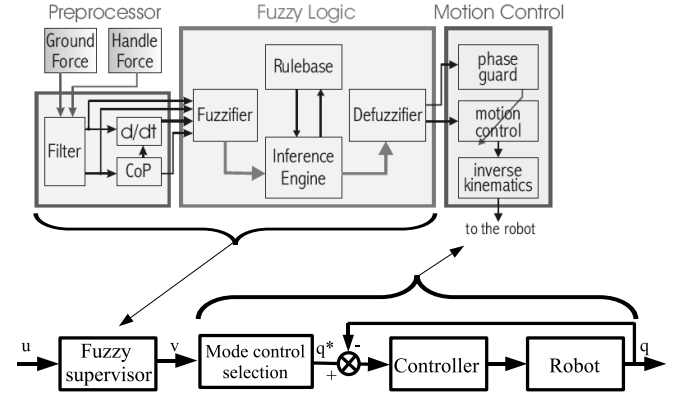

Fig. 11. Control structure

Inputs of this control are ground forces and handle forces. They are computed in a *preprocessing block* that applies a filter, calculates the position of CoP and its time derivatives. These outputs (u : stands for filtered handle and ground forces, CoP \vec{x} coordinate and its derivative) are processed by the *fuzzy logic block* to identify the postural state of the patient (v : represents output 1 and 2). Then, the corresponding control mode is selected between the four control modes listed in section II-D, it decides the desired joint position of the robot (q^*). The *controller* box is a classical PD position control refreshed at 100Hz frequency.

The outputs of this supervisor (v in Fig.11) are represented in Fig. 12. In this last figure, one can see that the supervisor can represent the different phases of the movement (Fig. 12(a)). A normal sit-to-stand motion supposes a regular augmentation of the fuzzy output. On Fig. 12(b), the second output that represents stability. If this output is close to zero, the postural state is stable. Fig. 12 shows the outputs given by the supervisor when the input given are subject records presented in section II-C.

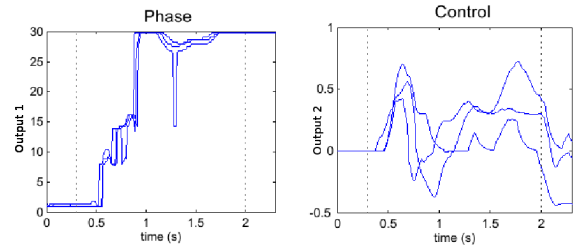

Fig. 12. Supervisor outputs: (a) represents phase identification, (b) shows stability representation

From all these rules derived from analysis of sit-to-stand motion, the controller is implemented as follows.

F. Controller

Admittance control mode is a simple admittance control:

$$\delta X = k * Fh + b * \frac{\delta X}{\Delta t} \quad (1)$$

$$X[t + 1] = X_{cur}[t] + \delta X \quad (2)$$

where k is a couple of coefficients equivalent to a spring, b represents damp coefficients, $X[t]$ are the Cartesian desired position of the handles for t time, Fh represents Forces measured on the handles, $X_{cur}[t]$ is current coordinates of handles at t time.

Normal control mode is a linear combination of admittance control and trajectory (X_{traj}) following, where $output2$ of the fuzzy system is a weight of admittance :

$$\delta X = output2 * (k * Fh + b * \frac{\delta X}{\Delta t}) \quad (3)$$

$$X[t + 1] = X_{traj}[t] + \delta X \quad (4)$$

In the case of instability, the **stabilization control** is the admittance control, eq. (3), weighted (A) to amplify X motions and to have no Y movement, it leads to eq. (5). Position computation is eq. (2).

$$\delta X = A * output2 * (k * Fh + b * \frac{\delta X}{\Delta t}) \quad (5)$$

And the trajectory is updated to fit with new situation.

The **return** control computes a linear reverse trajectory ($X_{rev_traj}[t]$) and comes back to initial position.

$$X[t] = X_{rev_traj}[t] \quad (6)$$

With this implemented control, the physical human-robot interaction can be evaluated on patients.

III. RESULTS

This section presents results on diseased patient performing sit-to-stand motion with the robot but the stability part of the control is not evaluated. Experiments on instability presents no acceptable scenario that both put the light on the instability and is safe for patients.

A. Clinical Results

This robotic device with its control has been evaluated on patients in hospital ‘‘URF-Bellan’’. These patients are affected by multiple sclerosis. In many cases, multiple sclerosis patients present cerebellar ataxia, that affects their motion with some tremors that can lead to disbalance and fall. The fuzzy controller has been evaluated on 10 patients presented in Table I.

This group of patients is composed of 6 males and 4 females. The average age of males (resp. females) is 36.5 years (resp. 51 years) with a standard deviation of ± 7.12 years (resp. ± 18 years). The average weight of males (resp. females) is 78.8 kg (resp. 59.7 kg) and the mean size of males is 1.80 m.

The synthetic table (I) shows the achievement of task (sit-to-stand) by patients supported by the robotic device controlled by our fuzzy logic controller.

ID	Gender	height	weight	age	# of trials	# of achieved
Patient1	M	1.90	85	40	10	8
Patient 2	M	1.75	74	39	15	14
Patient 3	M	1.77	71	24	10	9
Patient 4	M	1.84	86	37	11	9
Patient 5	M	1.89	94	34	12	11
Patient 6	M	1.65	63	45	13	11
Patient 7*	F	1.60		60?	1	1*
Patient 8	F	1.59	54	24	12	10
Patient 9	F		60	60?	5	4
Patient 10	F		65	60?	7	6

TABLE I

PATIENTS DATA AND ASSISTED SIT-TO-STAND ACHIEVEMENT

*the case of patient 7 is particular because she was affected of spasticity of one leg, feet sensor were unusable so fuzzy based control was not possible.

As we described in the previous part, two fuzzy outputs are managed by the supervisor. The first output represents different phases of the sit-to-stand movement and is presented in figure 13(a). This picture shows a sit-to-stand motion achieved by the patient without any difficulty or hesitation. However, we can see on this picture that phases of sit-to-stand motion are not well described by the supervisor, indeed the real outputs of the supervisor present some discontinuities in comparison to the motion of the simulated supervision (Fig. 12). The main reason of these picks is that action of the robot leads to discontinuities in derivatives of the ZMP that changes fuzzy state.

To fix that, we improved the control with a filter on the supervisor output checking if the output ν_1 used in the control is the maximum value of the ten preceding values of the output ν_1 of the supervisor. This filter gives in the worst case a delay of 100 ms in the control but this delay does not impact the good use of the robotic device. The result of this filtering is presented in figure 13(b) and is compared to the output result of the supervisor.

The second output (Fig. 13(c)) represents stability of the patient during the motion. As one can see, a lot of noise appears when the patient sat. This noise is not a problem because the supervisor is switched to a control for sitted patient that does not use stabilization information. Indeed, when a patient is sitted, the controller must choose between null-effort control for repositioning handles or initialization of rising motion.

When this motion is not achieved, fuzzy supervisor outputs are like in Fig. 14.

As one can see in Fig. 15, the controller is able to help a patient to stand-up. Note that the wheels are moving during the sit-to-stand motion in order to reduce the sustentation of the robot. It is also important to recall that all this motion is automatically controlled by the action of the patient.

This controller is compared with a simple trajectory control mode, one can notice in Fig. 16 that the fuzzy based control leads to less efforts with the ground but increase the time to stand up and the use of handles.

During these experimentations in the hospital, patients learn very quickly to use the robotic device. Indeed the average number of failures while using the robot in the

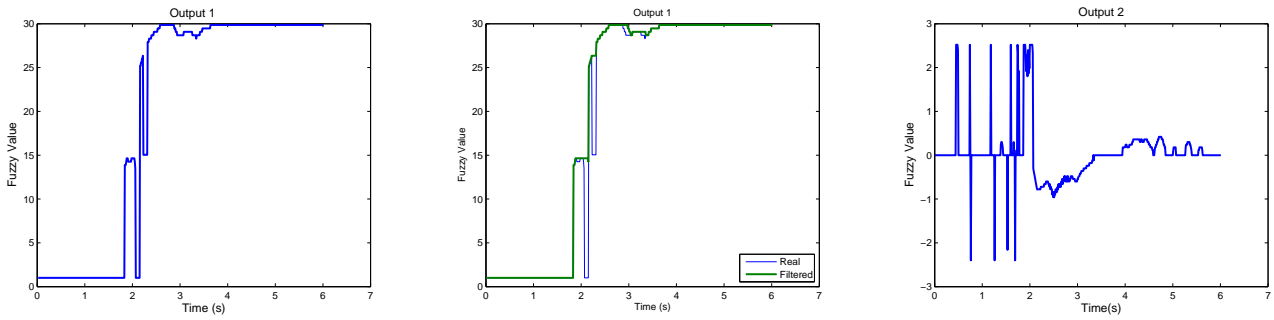

(a) Supervisor output 1 during a sit-to-stand motion of patient 8 (b) Filtered output ν_1 (Bold Line) Versus Direct Output ν_1 of the supervisor (c) Supervisor output 2 during a sit-to-stand motion of patient 8

Fig. 13. Outputs of different solutions

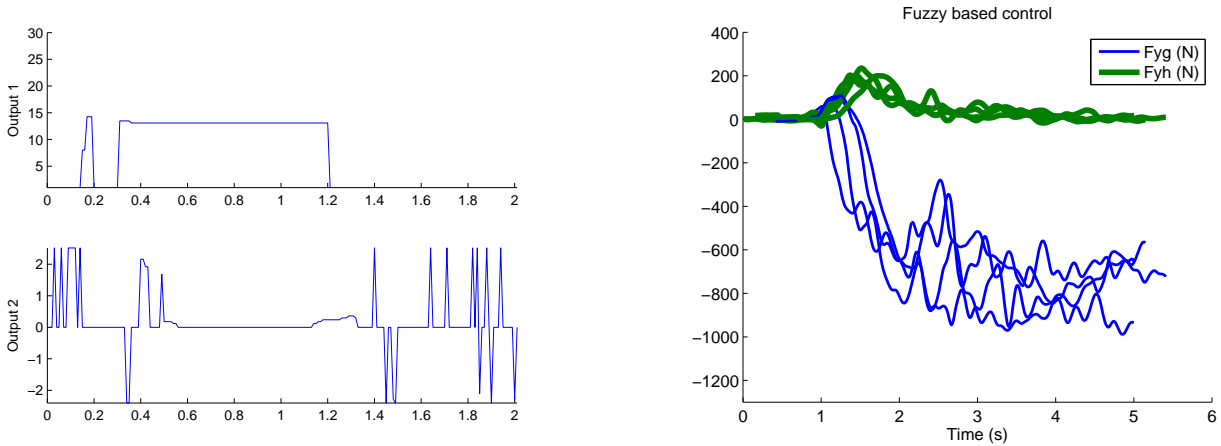

Fig. 14. Supervisor outputs for unachieved STS movement of patient 3

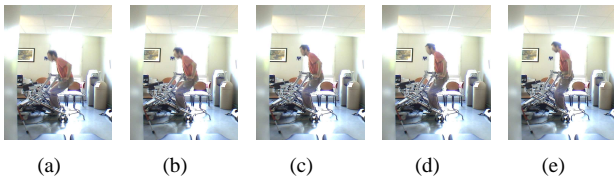

Fig. 15. Patient 3 automatically supported during his sit-to-stand transfer

sit-to-stand protocol is around 1, and the reason of this failure is often due to a bad positioning of the handles at the beginning. The natural position chosen by the patient is firstly too high and too far away from the trunk. That position is consequently too hard to maintain because it needs too much strength in the hands to support weight. After a failure, patients are advised to position the handles of the robot near the sides of the hips. And, when this position is used, the patient is able to stand-up without any trouble.

IV. DISCUSSION

The good learning rate is an interesting property of the system that is in our view due to the human centered design. All the design is done with the main idea to support a human body. The choice of handle is preferred to be more natural. Sensors chosen do not need any wearing of

equipment. Above all, the control is guided by motions which are as natural as possible and with the simplest possible communication. These choices lead to a robotic device that implies a very small cognitive load for the patient that helps patients to focus on their movement rather than on the device.

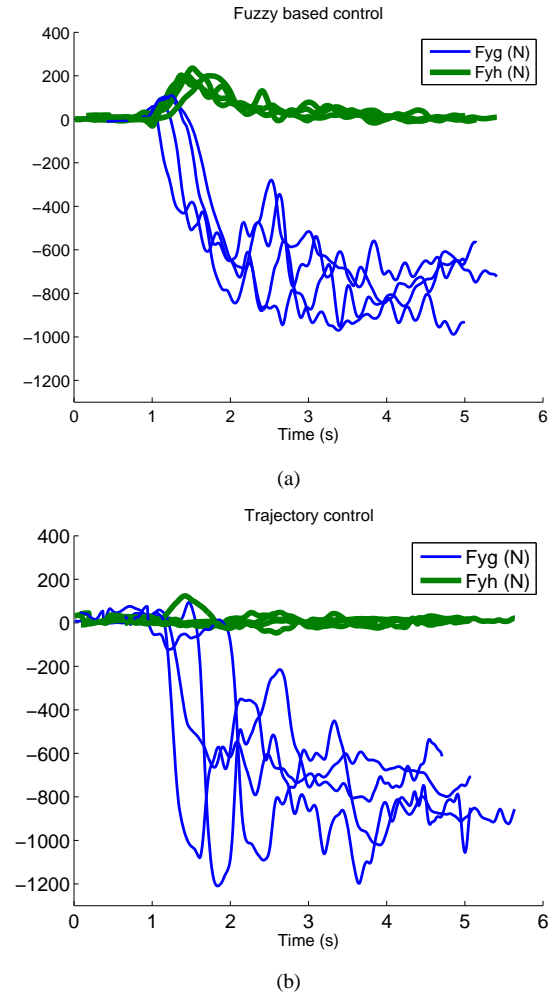

Fig. 16. Interaction forces (Fyh bold line and Fyg thin line) for 4 sit-to-stand motions of patient 1 while using fuzzy based control (16(a)) and trajectory based control (16(b))

However all these results are based on 10 patients and for 10 motions. We can conclude on the abilities of this device to support but this protocol needs to be experimented in hospital during years to really assess the rehabilitation ability of our system.

Another limitation of this work is the way fuzzy parameters are tuned. Indeed, tuning is based on a small set of data coming from healthy subjects furthermore it is one of the reason why there is a need of filtering. There is room in this part to optimize the way these parameters are tuned. In the same order of idea, it can also be interesting to propose some optimization strategies for the whole control tuning.

This work shows that a robot is able to identify the state of a patient and from Fig. 16 and with learning rate in Table I it is possible to affirm that intuitiveness is brought by this control. However it is not easy to quantify it and when also improvement of this control will be studied. It will be required to propose objective criteria that evaluate the feeling of the patient using robotic devices.

Finally the use of a ground force sensor becomes a limitation when we imagine protocols that combine sit-to-stand motions with walking. We need to develop some solutions that are able to work without a force sensor.

V. CONCLUSION

It has been shown in this paper that our rehabilitation robotics device with its fuzzy based control is able to assist patients in sit-to-stand motions. An asset of this control is its intuitiveness that patients need a very short time to learn using MONIMAD. The fuzzy-based control shows benefit from using a supervisor in the control loop to identify states of the human motion and determine the best strategy. This kind of control proposes an automatic device where each partner interacts physically with the other and a common movement emerges from this interaction. This reactive and interaction based kind of control improves the feeling of the patient and is a promising approach to rehabilitation.

REFERENCES

- [1] S. Jezernik, R. Schoerer, G. Colombo, and M. Morari, "Adaptive robotic rehabilitation of locomotion: a clinical study in spinally injured individuals," *Spinal Cord*, vol. 41, pp. 657–666, 2003.
- [2] C. G. L. L. Riener R., "Overview of robot-aided gait biofeedback and assessment," in *The First IEEE/RAS-EMBS International Conference on Biomedical Robotics and Biomechanics*, february 2006, pp. 965–970.
- [3] J. Kathryn and M. Syranosian, "Autoambulator improves functionality for healthsouth's rehab patients," http://www.braintreerehabhospital.com/pdf/autoambulator_MDNews.pdf.
- [4] R. D. Galvez J.A., "Robotics for gait training after spinal cord injury," *ord Inj Rehabil*, vol. 11, no. 2, pp. 18–33, 2005.
- [5] Schmidt, H., Hesse, S., Bernhardt, R., and Krüger J., "'hapticwalker - a novel haptic foot device'," *ACM Transactions on Applied Perception*, vol. 2, pp. 166–180, 2005.
- [6] M. Peshkin, D. A. Brown, J. J. Santos-Munné, A. Makhlin, E. Lewis, J. Colgate, J. Patton, and D. Schwandt, "Kineassist: A robotic over-ground gait and balance training device," in *roceedings of the 2005 IEEE 9th International Conference on Rehabilitation Robotics*, June 28 - July 1 2005, pp. 241–246.
- [7] C. Lee, K. Kim, S. Oh, and J. Lee, "A system for gait rehabilitation: mobile manipulator approach," in *IEEE Int. Conference on Robotics and Automation*, Washington, USA, 2002, pp. 3254–3259.
- [8] B. T. Kamnik R., "Standing-up robot: an assistive rehabilitative device for training and assessment," *Journal of Medical Engineering and Technology*, vol. 28, no. 2, p. 7480, march-april 2004.
- [9] D. Chugo, W. Matsuoka, S. Jia, and K. Takase, "Rehabilitation walker system for standing-up motion," *Proc. of 2007 IEEE/RSJ International Conference on Intelligent Robots and Systems*, 2007.
- [10] B. Graf, "Reactive navigation of an intelligent robotic walking aid," in *Proceedings of the IEEE International Workshop on Robot and Human Interaction: RO-MAN 2001*, Bordeaux-Paris, France, 2001, pp. 353–358.
- [11] D. Rodriguez-Losada, F. Matia, A. Jimenez, and R. L. G. Galan, "Implementing map based navigation in guido, the robotic smart walker," in *IEEE International Conference on Robotics and Automation, ICRA '05*, Barcelona, Spain, 2005, pp. 3401–3406.
- [12] H. A. K. K. Hirata Y., "Passive-type intelligent walking support system rt walker," in *Proceedings of 2004 IEEE/RSJ International Conference on Intelligent Robots and Systems*, September 28. October 2 2004, pp. 4303–4305.
- [13] P. Médéric, V. Pasqui, F. Plumet, P. Bidaud, and J. Guinot, "Elderly people sit to stand transfer experimental analysis," in *8th Int. Conference on Climbing on Walking Robots (CLAWAR'04)*, London, England, 2005, pp. 953–960.
- [14] P. Médéric, J. Lozada, V. Pasqui, F. Plumet, P. Bidaud, and J. Guinot, "An optimized design for an intelligent walking-aid," in *6th Int. Conference on Climbing on Walking Robots (CLAWAR'03)*, Catania, Italy, 2003, pp. 53–60.
- [15] P. Médéric, V. Pasqui, F. Plumet, P. Bidaud, and J. Guinot, "Design of a walking-aid and sit-to-stand transfer assisting device for elderly people," in *7th Int. Conference on Climbing on Walking Robots (CLAWAR'04)*, Madrid, Spain, 2004.
- [16] H. Chang and Y. Wang, "Design and performance of a piezoelectric actuated precise rotary positioner," *Proceedings on IEEE International Conference on Mechatronics*, pp. 313–317, 2005.
- [17] V. Pasqui, L. Saint-Bauzel, and P. Bidaud, "Postural stability control for robot-human cooperation for sit-to-stand assistance," in *Proceedings of the 10th International Conference on Climbing and Walking Robots*, 2007, pp. 409–416.
- [18] P. Sardain and G. Bessonnet, "Forces acting on a biped robot. center of pressure-zero moment point," *IEEE Transactions on Systems, Man, and Cybernetics, Part A: Systems and Humans*, vol. 34, no. 5, pp. 630–637, September 2004.
- [19] P. Médéric, "Conception et commande d'un système robotique d'assistance à la verticalisation et à la déambulation," Ph.D. dissertation, Université Pierre et Marie Curie-Paris06, 11 Dec. 2006.
- [20] B. KenKnight, R. Sweeney, J. Stahmann, and S. Girouard, "Cardiac rhythm management systems and methods predicting congestive heart failure status," *US Patent 7 127 290*, 2006.
- [21] S. Hussein and M. Granat, "Intention detection using a neuro-fuzzy EMG classifier," *Engineering in Medicine and Biology Magazine, IEEE*, vol. 21, no. 6, pp. 123–129, Nov.-Dec. 2002.
- [22] V. Pasqui, L. Saint-Bauzel, J. Graefenstein, and P. Bidaud, "Postural stability control for robot-human cooperation for sit-to-stand assistance," *Proceedings of Climbing and Walking Robots*, vol. 3, Jul. 2007.