



HAL
open science

A Tool for High-Level Modeling of Analog/Mixed Signal Embedded Systems

Daniela Genius, Rodrigo Cortés Porto, Ludovic Aprville, François Pêcheux

► **To cite this version:**

Daniela Genius, Rodrigo Cortés Porto, Ludovic Aprville, François Pêcheux. A Tool for High-Level Modeling of Analog/Mixed Signal Embedded Systems. MODELSWARD 2019 - 7th International Conference on Model-Driven Engineering and Software Development, Feb 2019, Prague, Czech Republic. pp.435-442, 10.5220/0007520804350442 . hal-01963837

HAL Id: hal-01963837

<https://hal.sorbonne-universite.fr/hal-01963837>

Submitted on 21 Oct 2019

HAL is a multi-disciplinary open access archive for the deposit and dissemination of scientific research documents, whether they are published or not. The documents may come from teaching and research institutions in France or abroad, or from public or private research centers.

L'archive ouverte pluridisciplinaire **HAL**, est destinée au dépôt et à la diffusion de documents scientifiques de niveau recherche, publiés ou non, émanant des établissements d'enseignement et de recherche français ou étrangers, des laboratoires publics ou privés.

A Tool for High-Level Modeling of Analog/Mixed Signal Embedded Systems

Daniela Genius¹, Rodrigo Cortés Porto^{1,3}, Ludovic Apvrille², François Pêcheux¹

¹ Sorbonne Université, LIP6, CNRS UMR 7606, Paris, France

² LTCI, Télécom ParisTech, Université Paris-Saclay, Paris, France

³ Technische Universität Kaiserslautern, Kaiserslautern, Germany

Keywords: Embedded Systems, Analog/Mixed Signal Design, Virtual Prototyping, Code Generation

Abstract: Embedded systems are commonly built upon heterogeneous digital and analog integrated circuits, including sensors and actuators. Model-driven approaches for designing software and hardware have been proposed, yet they are generally limited to the digital parts of systems. This paper presents the extension of an integrated modeling and simulation tool for the verification and virtual prototyping of embedded systems described at different abstraction levels to analog/mixed-signal systems.

1 Introduction

Model-driven techniques make use of high level models to create the specification of the software, and then rely on model transformations to generate the corresponding source code. They have been widely proposed for designing software **and** hardware. Nonetheless, in most cases, these approaches are limited to the digital part of the system, whereas embedded systems — e.g. robotics and automotive systems — are frequently built upon heterogeneous hardware e.g. processors, FPGAs, DSPs, hardware accelerators, digital and analog analog/mixed signal(AMS) and radio frequency(RF) circuits.

In very early design phases, rapid but less precise exploration of the design space is required. For this purpose, heterogeneous embedded systems require a high-level representation that includes models of their AMS and RF components. The problems of synchronization between the time domains of the different Models of Computation (MoC) however must be precisely considered.

This paper presents the integration of models for analog components into an existing multi-level modeling and virtual prototyping tool. In the modeling phase, we define a way to capture both digital and analog domains. In the prototyping phase, we propose a way to combine a Timed Data Flow (TDF) simulation with an event-based (SystemC) simulation.

Related work in the next section demonstrates the lack of an integrated approach offering at the same time high-level heterogeneous system modeling, for-

mal verification, correct-by-construction code generation, and cycle/bit precise simulation of both the digital and the analog parts. Section 3 presents the bases of this work, Section 4 our contribution and Section 5 provides results for a larger case study.

2 Related Work

Well established tools in analog/mixed signal design, like *Ptolemy II* [Ptolemy.org, 2014], based upon a data-flow model, address heterogeneous systems by defining several sub domains using hierarchical models. Instantiation of elements controlling the time synchronization between domains is left to the responsibility of designers.

Metropolis [Balarin et al., 2003] is based on a high level model and facilitates the separation of computation from communication concerns. Heterogeneous systems are taken into consideration, but heterogeneity can only be represented using processes, mediums, quantities and constraints. Hierarchical models are not allowed: all processes should be implemented in the same hierarchical level. Metro II [Davare et al., 2007] introduces hierarchy and allows *Adaptors* for data synchronization as a bridge between the semantics of components belonging to different MoCs. The model designer still has to implement time synchronization. As a common simulation kernel handles all process execution, MoCs are not well separated.

SystemC [IEEE, 2011] is a C++ class library which makes it possible to model (digital) hardware

on multiple levels of abstraction. Among the frameworks based on SystemC are HetSC [Herrera and Villar, 2007], HetMoC [Zhu et al., 2010] and ForSyDe [Niaki et al., 2012], all having the disadvantage that instantiation of elements and controlling the synchronization have to be managed by the designer.

SystemC-AMS extensions [Accellera Systems Initiative, 2010] is a standard describing an extension of SystemC with AMS and RF features [Vachoux et al., 2003]. The usual approach for modeling the digital part of a heterogeneous system with SystemC is to rely on the *Discrete Event* (DE) part of SystemC AMS extensions. The *Timed data Flow* (TDF) part adds support for signals where data values are sampled with a constant time step.

In the scope of the project BeyondDreams [Beyond Dreams Consortium, 2011], a mixed analog-digital systems proof-of-concept simulator has been developed, based on the SystemC AMS extension standard. Another simulator is proposed in the H-Inception project [H-Inception Consortium, 2015]. All of these approaches rely on SystemC AMS code i.e. they don't provide a high-level interface for specifying the application.

Outside the analog/mixed signal domain, UML/SysML based modeling techniques such as MARTE and Gaspard2 [Vidal et al., 2009, Selic and Gérard, 2013, Gamatié et al., 2011] are popular for capturing embedded systems, but are scarcely used for heterogeneous system design with virtual prototyping in mind. Furthermore, with very few exceptions such as [Taha et al., 2010, Li et al., 2018], they do not support refinement until a low level of abstraction i.e. cycle bit accurate level nor provide full-system simulation.

The B method and more recently Event-B [Abrial, 2010] model systems at different abstraction levels and makes it possible to mathematically prove consistency between refinement levels. Based on set theory and the B language, the B method is well established in large-scale public/private projects (urban transports etc.) but less widespread in industry than UML/SysML based approaches.

Very few works exist which bridge the gap between digital and analog aspects. One of these contributions stems from the Microelectromechanical systems (MEMS) community [Bouquet et al., 2012]. It transforms structural SysML diagrams to VHDL-AMS code. Another is Discrete Event System Specification (DEVS [Concepcion and Zeigler, 1988]), a modular and hierarchical formalism for modeling and analyzing general systems that can be discrete event or continuous state systems; the latter can be described by differential equations, or hybrid systems.

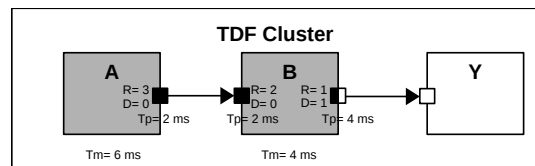

Figure 1: TDF Cluster

3 Preliminaries

Timed Data Flow SystemC AMS uses among others the Timed Data Flow (TDF) Model of Computation which is based on the timeless Synchronous Data Flow (SDF) semantics [Lee and Messerschmitt, 1987b]. A TDF module is described with an attribute representing the time step and a processing function. The processing function corresponds to a mathematical function which depends on the module inputs and/or internal states. At each time step, a TDF module first reads a fixed number of samples from each of its input ports, then executes the processing function, and finally writes a fixed number of samples to each of its output ports. TDF modules can interact with the DE world (such as digital MPSoC platforms) using converter ports.

Figure 1 shows a TDF cluster. DE modules are represented as white blocks, TDF modules as gray blocks, TDF ports as black squares, TDF converter ports as black and white squares, DE ports as white squares and TDF signals as arrows. So-called **converter ports**, shown as black-and white squares, serve as interface between the TDF and DE MoC. The TDF modules have the following attributes:

- **Module Timestep (Tm)** denotes the period during which the module will be activated. One module will only be activated if there are enough samples available at its input ports.
- **Rate (R)**. Each module will read or write a fixed number of data samples each time it is activated. This number is annotated to the ports and it is known as the port rate.
- **Port Timestep (Tp)** is the period during which each port of a module will be activated. It also denotes the time interval between two samples that are being read or written.
- **Delay (D)**. A delay D can be assigned to a port to make it store a given number of samples each time it is activated, and read or write them in the next activation.

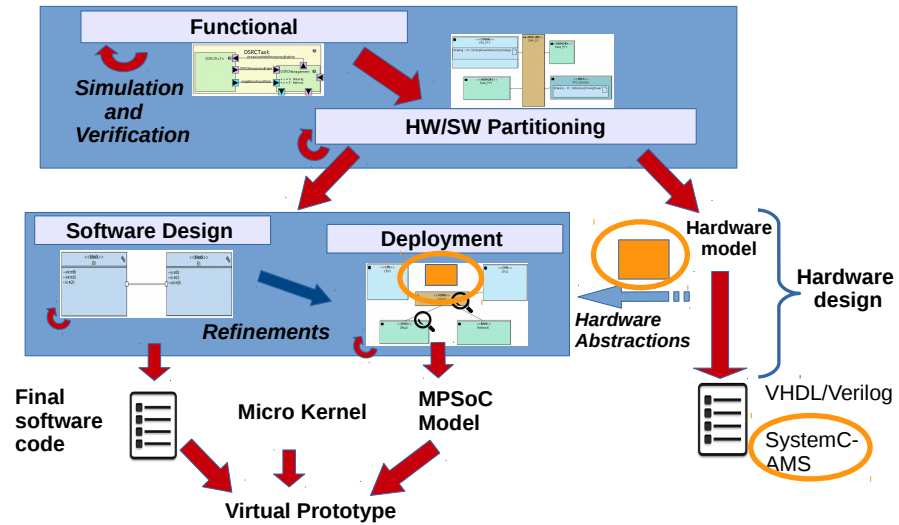

Figure 2: Hardware/Software partitioning and Code generation for MPSoC platforms

Modeling Tool TTool [Aprville, 2011] is a SysML based, free and open-source software initially designed for model-based engineering of (digital) embedded systems at different abstraction levels: functional, partitioning, software design, and deployment. To each of these levels, as shown in Figure 2, is associated a separate *panel*. The method associated to these levels explains how to take hardware/software partitioning decisions at a high level of abstraction and to regularly validate these decisions during software development [Li et al., 2018].

Software tasks for the partitioning model are captured within the functional abstraction level, and software tasks used in deployments are captured in the software design abstraction level. In both partitioning and deployment, the computation part of tasks is then deployed to processors and hardware accelerators, and the communication and storage parts are deployed to buses and memories.

TTool allows verification and fast simulation for the digital part but also cycle bit accurate virtual prototyping on a Multi-Processor System-on-Chip (MPSoC) based on the *SoCLib* [SocLib consortium, 2003] public domain library written in SystemC. As SystemC-AMS is an extension to SystemC, the choice of this tool for integrating analog/mixed signal components was natural.

4 Integration of Analog Components

In the following, we show how TDF concepts can be integrated into a high-level modeling and virtual prototyping tool, while maintaining as far as possi-

ble the idea of correct-by-construction code generation. Figure 2 uses orange circles to explain how the methodology described above has to be adapted to AMS components in TTool. Hardware parts, shown on the lower right, can be simulated with a cycle-accurate precision. Analog/Mixed Signal components are not represented on the partitioning level, as the decision to have them implemented in hardware or software is not in the hands of the designer of the embedded platforms. They must thus be visible in the deployment diagram, from which the hardware top-cell and the description of the mapping of software objects to processors, memories and communication elements is generated.

Our contribution is twofold: represent SystemC-AMS components in the Deployment Diagram and integrate the the communication between digital and analog part of the platform in the prototyping code.

4.1 Graphical Representation of Analog Components in TTool

TTool has been extended with an abstract way to capture SystemC-AMS blocks with their DE, TDF and converter ports. Each TDF cluster is designed in its own panel because SystemC-AMS must calculate a separate schedule [Accellera Systems Initiative, 2010] for each of them. When a TDF module is created, it is possible to modify its attributes and parameters. The name and Timestep or Period (Tm) of a module can be defined and time resolution selected. The parameters of a TDF module such as its internal variables or template parameters can be also set up, as it is shown in Figure 3.

Analog components are difficult to parametrize, since most components are more or less unique. Our current (and temporary) solution is to offer a dialog window where the SystemC-AMS `processing()` function can be provided, as shown in Figure 4.

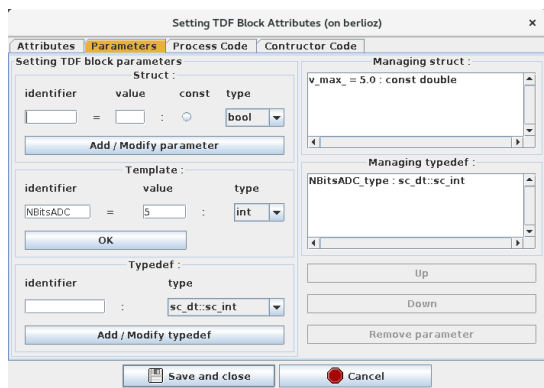

Figure 3: TDF module parameters

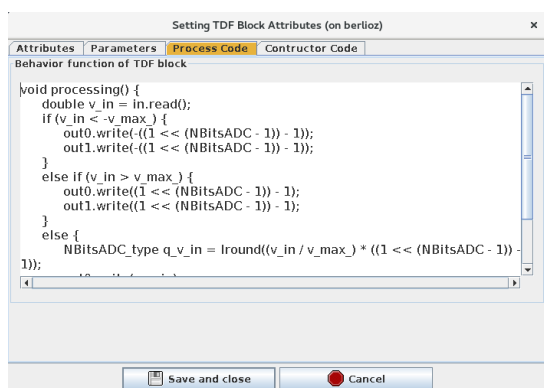

Figure 4: TDF module process code

4.2 MPSoC Virtual Prototype

If the deployment model contains only SystemC-AMS clusters, then TTool generates SystemC AMS TDF code of the components as well as the SystemC-AMS top cells from the mixed graphical/textual descriptions, and supplies a Makefile. In case software code is also deployed, processors / buses / memories must also be generated. SoCLib offers a way to describe Multi-Processor System-on-Chip platforms with semantics based on the shared memory paradigm, where digital components are interconnected with VCI [VSI Alliance, 2000] interfaces. Components can be **initiators** issuing requests (typically CPUs and hardware accelerators), or **targets** answering to requests (e.g. RAM).

In order to combine SoCLib specification with SystemC-AMS components, we have defined generic

adaptor modules that can connect SystemC-AMS components to VCI interfaces. An adaptor is modeled as a **general-purpose input/output**(GPIO) target component, following the modeling rules for writing cycle-bit precise SystemC simulation models for SoCLib described below. GPIO components are visible in the deployment diagram, and, like the other VCI components, their interconnection to the central VCI interconnect is represented by an arc. Clicking on one of the GPIO opens the corresponding TDF cluster. Finally, the generated topcell is thus composed of SoCLib modules and interfaces to the SystemC-AMS clusters.

4.3 Simulation

Due to their different Model of Computation, AMS components require to execute their simulated behavior apart from the rest of the system, but regularly synchronize with the digital platform. The SystemC kernel is **controlling** the AMS kernel: the AMS kernel runs continuously until it is interrupted by and access to a converter port by a TDF cluster. When the TDF module accesses its input converter port, the DE simulation time advances until it is equal to the TDF simulation time of the input converter port. If later an access to an output converter port occurs with a TDF simulation time that is less than the new DE simulation time, a time synchronization issue occurs. To avoid this situation, the TDF simulation time of the output converter ports always needs to be greater or equal than the DE simulation time. This problem was exposed in [Andrade et al., 2015]. Since model-driven approaches expect to ideally provide model validation **before** code generation (and thus simulation), we propose a way to statically identify synchronization problems [Cortés Porto, 2018]. The schedulability of the analog part is validated using the schedulability check of SystemC-AMS [Lee and Messerschmitt, 1987a], before code is generated.

5 Case Study: Rover

A rover system, intended to assist rescuers to find victims buried in rubble, consists of four components: central control and motor control and the two sensors, a distance sensor and a temperature sensor.

In the rover case study already published in [Genius et al., 2018], we replace the two sensors by more realistic analog models (TDF still being an abstraction of the analog behavior). Central and motor control are still modeled as digital components, whereas the two sensors are modeled as independent TDF clusters. As

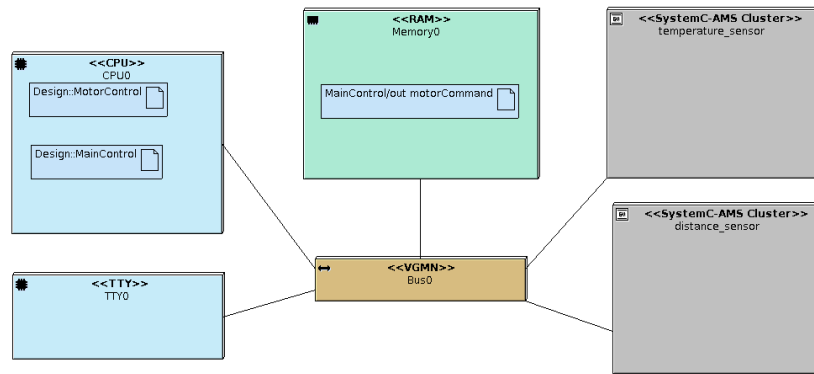

Figure 5: Deployment Diagram model of the rover

the partitioning decision has already been taken for the analog blocks, they are not part of functional and partitioning views.

5.1 Software Design

Figure 5 shows the deployment diagram where the two software tasks (`MainControl`, `motorControl`) are mapped onto the CPU, the channel between the tasks on the memory. TDF clusters appear as gray boxes along with digital components, interconnected to the central (digital) interconnect through GPIO components as detailed below;

5.2 Diagrams for TDF Clusters

SystemC-AMS Component Diagram panels are shown in Figures 6 and 7.

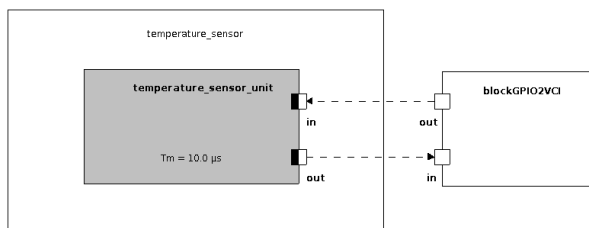

Figure 6: Temperature sensor model

The temperature sensor cluster is composed of one single TDF module. The behavior of this module, which is a simplification of the actual behavior of a temperature sensor, is described as SystemC-AMS code. It depends on the value received on its input port `in`, which is connected to the digital components of the system via a GPIO2VCI component. A value of 0 means that the temperature sensor should be turned off. If a value different from 0 is received, then the temperature sensor will generate random integer val-

ues from 0 to 30, representing the temperature currently measured. Temperature values are written to the output port `out` of the module which is also connected to the GPIO2VCI component. Hence, the values will be available to be read by the digital components of the system. The temperature sensor will operate in timesteps of $10 \mu s$.

The distance sensor cluster shown in Figure 7, is composed of three distinct TDF modules, each modeling an ultrasonic sensor. These are connected to a DE module modeling the controller which reads values from each of the ultrasonic sensors and writes a value to the GPIO2VCI component, depending on the value obtained from its input `in`.

A value of 0 makes it read from the `ultrasonic_sensor_left`, a value of 1 from the `ultrasonic_sensor_front`, a value of 2 from the `ultrasonic_sensor_right`. Each ultrasonic sensor produces random values (from 0 to 12) in timesteps of 100 ns. The behavior of this cluster is a simplification of the behavior of a real distance sensor, since the focus of the paper is mostly on the communication between the digital and analog aspects.

5.3 Interaction of Analog Blocks with the Software Design Level

On the software side of the model, two blocks have been created to represent the `MotorControl` and the `MainControl` (not shown). They represent the software design level shown on the lower left of Figure 2. In contrast to the purely digital model of the same application, the functional blocks pertaining to the sensors are no longer represented in the block diagram, since they are represented by analog blocks captured in two separate SystemC-AMS panels.

Both blocks communicate with each other through a signal `motorCommand` which is sent by the

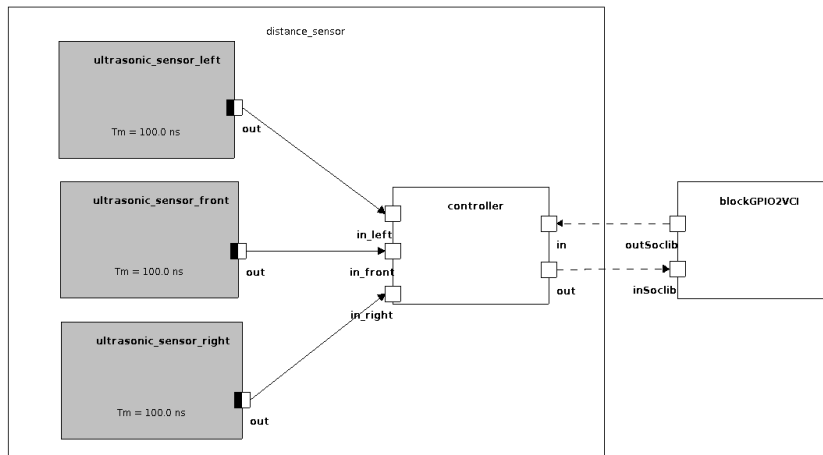

Figure 7: Distance sensor model

MainControl to the MotorControl and contains two parameters for the right and left velocity. The blocks also initialize internal attributes.

The state machine of the MotorControl block has only one state `startMotor`. It receives the two velocity parameters from the `motorCommand` signal and waits for some random time between 10 and 20 clock cycles. The state machine of the MainControl block is shown in Figure 8. In the following, we provide a more detailed description of the states, specially the ones that interact with the TDF clusters. By executing software functions, the CPU of the digital platform is able to write or read values from the analog components. During the first state `startController`, the variable `sensorOn`, initialized to 0 in the MainControl block, and written to the GPIO2VCI component connected to the temperature sensor cluster. The C code inserted into the `startController` state, shown in the upper part of Figure 9, turns the temperature sensor unit module off. Figure 10 shows the local host console output.

In the next state `readDistanceSensor`, each ultrasonic sensor is selected in turn by writing a different value to the distance sensor cluster, then the sensor output is read and the read value is printed to the TTY component of the model, as shown in the code from Figure 9.

After this, the next state `calculateDistance` simulates how the velocity of the rover is calculated based on the front distance that was read as shown in the state diagram of Figure 8. If the distance was large (greater than 8), the state condition will lead to `state0` and a normal speed would be set (a value of 5). If the distance was between 3 and 8, it would go to `state1` and a low speed (a value of 2) would be set. In this case, since the front distance was 2 less than 3, the `calculateDistance` state condition will lead

to `state2`. Here the state variable is set to 2. Then it proceeds to the `controlTempSensor` state, where, since `state = 2`, `sensorOn` is set to 1. In the subsequent `setTempSensor` state, the temperature sensor unit is turned on or off by writing the value of the `sensorOn` variable to the temperature sensor cluster as shown in the lowest part of Figure 9. In the output from the local host machine, we observe that at time 3196116 ns, a value of 1 is written to the GPIO2VCI component. At this point the temperature sensor unit is turned on.

In the following states, the rover will measure the temperature. Depending on the state variable, the `turnDecision` state will decide if the rover needs to turn or not. If the distance is greater or equal than 3, then the state variable will be 0 or 1, and the rover will neither measure temperature nor turn. In our case the distance is 2 and the state variable is 2, so it goes to the next state `measureTemp`.

In the `measureTemp` state, the temperature sensor cluster is read and the temperature is printed to the TTY, as shown in the lowest part of Figure 9. In the local host console (Figure 10), at time 3935019 ns a value of 21 is read. The output on the TTY is shown in the lower red rectangle from Figure 11.

The `dodgeObstacle` state calculates whether the rover needs to turn left or right, based on the distance measured from the left and right ultrasonic sensors; it will set the velocity of the left or right motors accordingly. After turning left or right, the `motorCommand` signal is sent to the motor control state machine, so that it can adjust the velocity of the motors. Finally, the main control state machine loops again to the `readDistanceSensor` state to start a new cycle.

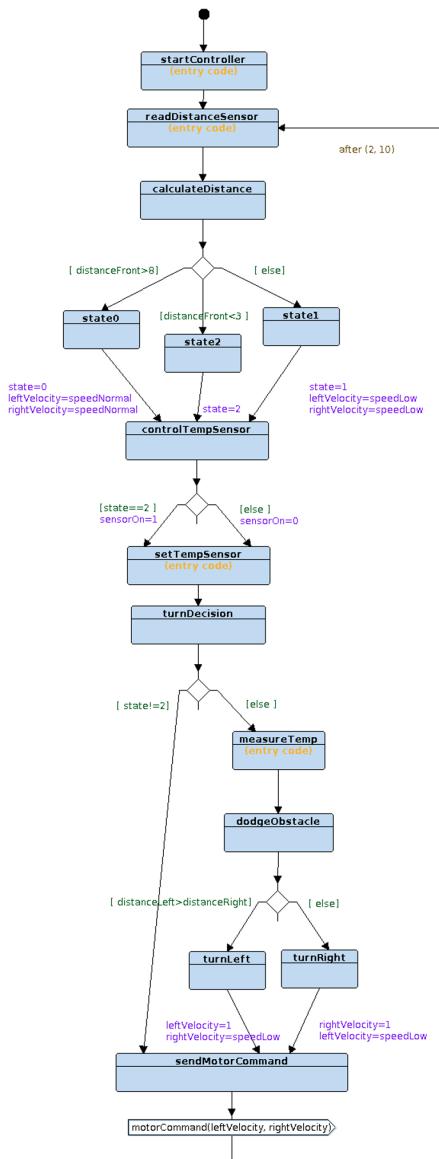

Figure 8: Main control state machine with entry code in the startController, readDistanceSensor, setTempSensor and measureTemp states

6 Conclusion and Perspectives

The paper shows the integration of SystemC-AMS (TDF) components into a multi-level modeling tool for complex embedded systems. Virtual prototyping can be performed from the last refinement stage, taking into account both analog and digital parts of the system. To this end, a library was created to provide read and write functions between the digital and analog components, which can be used in State Machine Diagrams modeling software behaviors. Code generation of TTool was extended to SystemC-AMS code.

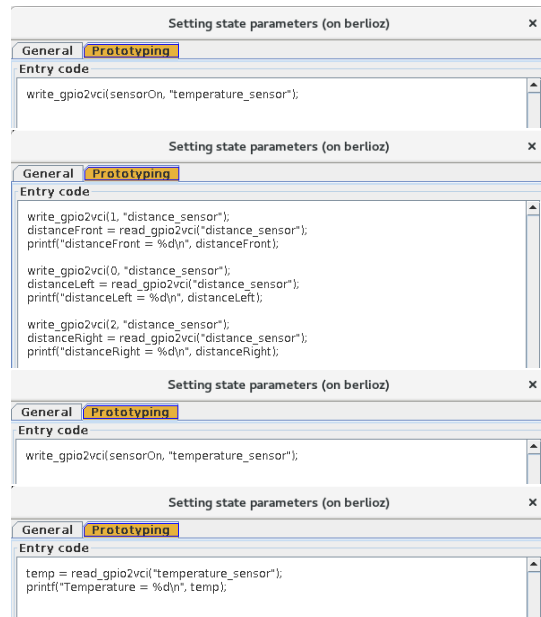

Figure 9: Entry code in the Prototyping window tab

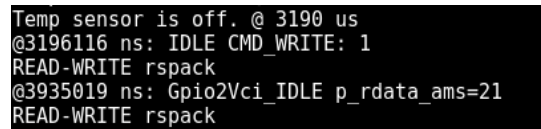

Figure 10: Simulation output from host machine console

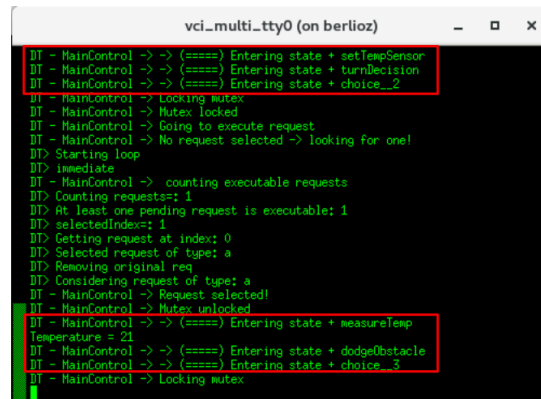

Figure 11: Simulation output from the TTY component console - setTempSensor and measureTemp state.

Yet, in order to use these functions, C entry code needs to be inserted in the state blocks of the TTool diagram. In the future, this should be replaced by specific read and write operators.

The feedback of simulation results is currently still limited to the digital part and only semi-automatic. Automating and extending this mechanism to the entire system would enable us to propose a full design space exploration environment for Analog/Mixed Signal systems.

REFERENCES

- Abrial, J.-R. (2010). *Modeling in Event-B: system and software engineering*. Cambridge University Press.
- Accellera Systems Initiative (2010). *SystemC AMS extensions Users Guide, Version 1.0*. Accellera Systems Initiative.
- Andrade, L., Maehne, T., Vachoux, A., Ben Aoun, C., Pêcheux, F., and Louërat, M.-M. (2015). Pre-Simulation Formal Analysis of Synchronization Issues between Discrete Event and Timed Data Flow Models of Computation. In *Design, Automation and Test in Europe, DATE Conference*.
- Apvrille, L. (2011). *Webpage of TTool*.
- Balarin, F., Watanabe, Y., Hsieh, H., Lavagno, L., Passerone, C., and Sangiovanni-Vincentelli, A. L. (2003). Metropolis: An integrated electronic system design environment. *IEEE Computer*, 36(4):45–52.
- Beyond Dreams Consortium (2008-2011). *Beyond Dreams (Design Refinement of Embedded Analogue and Mixed-Signal Systems)*. <http://projects.eas.iis.fraunhofer.de/beyonddreams>.
- Bouquet, F., Gauthier, J.-M., Hammad, A., and Peureux, F. (2012). Transformation of sysml structure diagrams to vhdl-ams. In *2012 Second Workshop on Design, Control and Software Implementation for Distributed MEMS*, pages 74–81. IEEE.
- Concepcion, A. I. and Zeigler, B. P. (1988). DEVS formalism: A framework for hierarchical model development. *IEEE Transactions on Software Engineering*, 14(2):228–241.
- Cortés Porto, R. (2018). Integration of SystemC-AMS simulation platforms into TTool. Master’s thesis, Technische Universität Kaiserslautern.
- Davare, A., Densmore, D., Meyerowitz, T., Pinto, A., Sangiovanni-Vincentelli, A., Yang, G., Zeng, H., and Zhu, Q. (2007). A next-generation design framework for platform-based design. In *DV-Con*, volume 152.
- Gamatié, A., Beux, S. L., Piel, É., Atitallah, R. B., Etien, A., Marquet, P., and Dekeyser, J.-L. (2011). A model-driven design framework for massively parallel embedded systems. *ACM Trans. Embedded Comput. Syst*, 10(4):39.
- Genius, D., Li, L. W., and Apvrille, L. (2018). Multi-level Latency Evaluation with an MDE Approach. In *MODELSWARD*.
- H-Inception Consortium (2012-2015). *Heterogeneous Inception Project*. <https://www-soc.lip6.fr/trac/hinception>.
- Herrera, F. and Villar, E. (2007). A framework for heterogeneous specification and design of electronic embedded systems in systemc. *ACM Transactions on Design Automation of Electronic Systems (TODAES)*, 12(3):22.
- IEEE (2011). *SystemC*. IEEE Standard 1666-2011.
- Lee, E. A. and Messerschmitt, D. G. (1987a). Static Scheduling of Synchronous Data Flow Programs for Digital Signal Processing. *IEEE Transactions on Computers*, C-36(1):24–35.
- Lee, E. A. and Messerschmitt, D. G. (1987b). Synchronous data flow. *Proceedings of the IEEE*, 75(9):1235–1245.
- Li, L. W., Genius, D., and Apvrille, L. (2018). Formal and virtual multi-level design space exploration. In *MODELSWARD, Springer Communications in Computer and Information Science, vol 880*, pages 47–71.
- Niaki, S. H. A., Jakobsen, M. K., Sulonen, T., and Sander, I. (2012). Formal heterogeneous system modeling with systemc. In *Specification and Design Languages (FDL), 2012 Forum on*, pages 160–167. IEEE.
- Ptolemy.org, editor (2014). *System Design, Modeling, and Simulation using Ptolemy II*.
- Selic, B. and Gérard, S. (2013). *Modeling and Analysis of Real-Time and Embedded Systems with UML and MARTE: Developing Cyber-Physical Systems*. Elsevier.
- SocLib consortium (2003). The SoCLib project: An integrated system-on-chip modelling and simulation platform. Technical report, CNRS. www.soclib.fr.
- Taha, S., Radermacher, A., and Gérard, S. (2010). An entirely model-based framework for hardware design and simulation. In *DIPES/BICC*, volume 329 of *IFIP Advances in Information and Communication Technology*, pages 31–42. Springer.
- Vachoux, A., Grimm, C., and Einwich, K. (2003). Analog and mixed signal modelling with SystemC-AMS. In *ISCAS (3)*, pages 914–917. IEEE.
- Vidal, J., de Lamotte, F., Gogniat, G., Soulard, P., and Diguet, J.-P. (2009). A co-design approach for embedded system modeling and code generation with UML and MARTE. In *DATE*, pages 226–231. IEEE.
- VSI Alliance (2000). *Virtual Component Interface Standard (OCB 2 2.0)*.
- Zhu, J., Sander, I., and Jantsch, A. (2010). Hetmoc: Heterogeneous modelling in systemc. In *Specification & Design Languages (FDL 2010), 2010 Forum on*, pages 1–6. IET.