



HAL
open science

The first decades of Doppler-free two-photon spectroscopy

François Biraben

► **To cite this version:**

François Biraben. The first decades of Doppler-free two-photon spectroscopy. *Comptes Rendus. Physique*, 2019, 20 (7-8), pp.671 - 681. 10.1016/j.crhy.2019.04.003 . hal-02408629

HAL Id: hal-02408629

<https://hal.sorbonne-universite.fr/hal-02408629>

Submitted on 13 Dec 2019

HAL is a multi-disciplinary open access archive for the deposit and dissemination of scientific research documents, whether they are published or not. The documents may come from teaching and research institutions in France or abroad, or from public or private research centers.

L'archive ouverte pluridisciplinaire **HAL**, est destinée au dépôt et à la diffusion de documents scientifiques de niveau recherche, publiés ou non, émanant des établissements d'enseignement et de recherche français ou étrangers, des laboratoires publics ou privés.



Science in the making 2: From 1940 to the early 1980s / *La science en mouvement 2 : de 1940 aux premières années 1980*

The first decades of Doppler-free two-photon spectroscopy



Les premières décennies de la spectroscopie à deux photons sans élargissement Doppler

François Biraben

Laboratoire Kastler Brossel, Sorbonne Université, CNRS, ENS-PSL University, Collège de France, 4, place Jussieu, 75005 Paris, France

ARTICLE INFO

Article history:

Available online 16 May 2019

Keywords:

Hydrogen spectroscopy
Two-photon transition
Rydberg constant
Proton radius

Mots-clés :

Spectroscopie de l'hydrogène
Transition à deux photons
Constante de Rydberg
Rayon du proton

ABSTRACT

This paper gives a review of the Doppler-free two-photon experiments performed since the beginning of the 1970s until the end of the 1990s. The Doppler-free two-photon method was first tested on the sodium atom, then used extensively to study the hydrogen atom and measure the Rydberg constant and the Lamb shifts.

© 2019 Académie des sciences. Published by Elsevier Masson SAS. This is an open access article under the CC BY-NC-ND license (<http://creativecommons.org/licenses/by-nc-nd/4.0/>).

R É S U M É

Cet article présente une revue des expériences de spectroscopie à deux photons sans effet Doppler, réalisées depuis le début des années 1970 jusqu'à la fin des années 1990. La méthode de spectroscopie à deux photons sans élargissement Doppler a d'abord été testée sur l'atome de sodium, puis elle a été utilisée extensivement pour étudier l'hydrogène atomique et mesurer la constante de Rydberg et les déplacements de Lamb.

© 2019 Académie des sciences. Published by Elsevier Masson SAS. This is an open access article under the CC BY-NC-ND license (<http://creativecommons.org/licenses/by-nc-nd/4.0/>).

1. Introduction

At the beginning of the 1970s, Bernard Cagnac proposed the method of Doppler-free two-photon spectroscopy. The principle of a two-photon transition is illustrated in Fig. 1. An atom interacting with two electromagnetic waves of angular frequencies ω_1 and ω_2 absorbs simultaneously two photons and passes from the energy level g to the energy level e if the resonance condition is fulfilled:

$$E_e - E_g = \hbar\omega_1 + \hbar\omega_2 \quad (1)$$

The theory of the two-photon transition was developed in 1931 by Maria Goppert-Mayer [1]. The transition probability is proportional to the product of the intensities of the electromagnetic waves, and, consequently, the observation of a two-photon transition needs a large light intensity. The intermediate levels r_i , which are linked by a single-photon transition

E-mail address: francois.biraben@spectro.jussieu.fr.

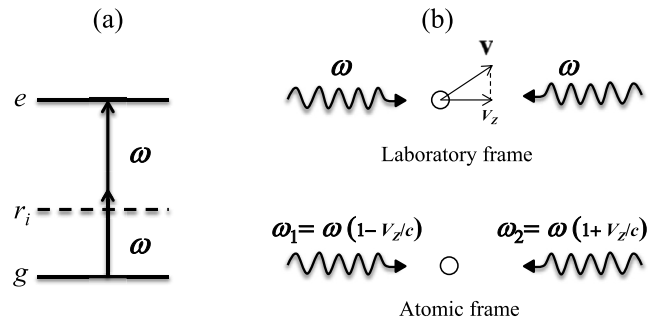

Fig. 1. (a) The atom absorbs simultaneously two photons of angular frequency ω ; (b) Principle of Doppler-free two-photon spectroscopy: in the laboratory frame, the atom of velocity \mathbf{v} is illuminated by two counterpropagating waves of the same frequency; in the atomic frame, these two frequencies are up- and down-shifted because of the Doppler effect. These shifts are opposite and cancel.

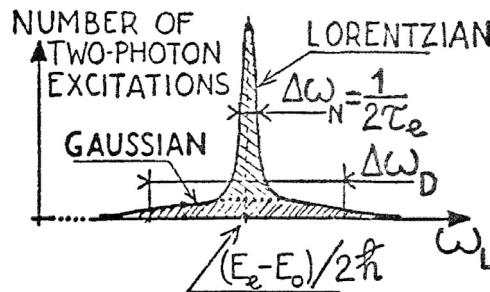

Fig. 2. This figure was drawn by Bernard Cagnac in his inimitable style. It shows the line shape of the two-photon absorption of an atomic vapor in a standing wave. The Lorentzian peak corresponds to the Doppler-free absorption and the Gaussian curve to the Doppler broadened absorption. In the case where the two counterpropagating waves have the same polarization, the theory predicts that the area of the Lorentzian curve is twice the one of the Gaussian curve. As the Doppler width $\Delta\omega_D$ is in general larger by several orders of magnitude than the Lorentzian width $\Delta\omega_N$, the Gaussian curve appears as a small background; ω_L is the laser angular frequency, τ_e the lifetime of the upper level (energy E_e), the initial level (energy E_0) is a ground state.

to the levels g and e , appear in the calculation of the two-photon transition probability. This probability is all the more large as the energy E_{r_i} of one of the intermediary levels r_i is close to the midway point between the energies E_g and E_e . These transitions were observed at the beginning of the 1950s in the radio frequency domain by L. Grabner and V. Hughes [2,3], P. Kusch [4], and in the group of Kastler and Brossel [5]. They were then observed in the optical domain thanks to the development of lasers, which produce a large enough intensity. In 1962, Abella observed a two-photon transition in cesium by using a frequency coincidence with a ruby laser [6]. At the beginning of the 1970s, the advent of tunable lasers enabled the development of this kind of experiment.

In an atomic vapor, the motion of the atoms produces a broadening of the spectral line: the angular frequency ω of the incident line is shifted by the Doppler effect, and, in the atomic frame, the angular frequency is $\omega - \mathbf{k} \cdot \mathbf{v}$. The principle of the method proposed by Bernard Cagnac was to induce a two-photon transition in a standing wave of angular frequency ω . If the atom absorbs one photon of each counter-propagating wave, the resonance condition becomes:

$$E_b - E_a = \hbar(\omega - \mathbf{k} \cdot \mathbf{v}) + \hbar(\omega + \mathbf{k} \cdot \mathbf{v}) = 2\hbar\omega \quad (2)$$

This condition is independent of the atomic velocity and the absorption line is not broadened by the Doppler effect. All the atoms absorb two photons at the same angular frequency and this produces a resonance whose width is the natural width. Moreover, as the momentum transferred from the photons to the atom is zero, there is also no recoil effect. The atom can also absorb two photons from the same propagating wave: in this case the Doppler shifts of each photon add and the resonance condition is fulfilled for only one velocity class. Then the absorption line shape consists of a narrow Doppler-free central peak on a wider Doppler broadened pedestal (see Fig. 2).

In 1971, to exploit this idea, Bernard Cagnac founded in our laboratory an experimental group with Gilbert Grynberg, which I joined one year later. In an article in the *Bulletin de la SFP*, Gilbert Grynberg relates the beginning of our team [7]. The proposition of Cagnac was very attractive because of its simplicity and its novelty. Nevertheless, at this time, the observation of the Doppler-free two-photon absorption appeared a very difficult experiment and Grynberg relates that, when he decided to work with Cagnac, most of the members of the laboratory were very skeptical, except Serge Haroche and Claude Cohen-Tannoudji. Because of our inexperience in laser systems, Cagnac had decided not to communicate his idea. Thus we were very disappointed when we learned, following a visit of V. S. Letokhov to our laboratory, that this idea had been published two years earlier by L.S. Vasilenko, V.P. Chebotayev, and A.V. Shishaev [8]. This prompted Cagnac to

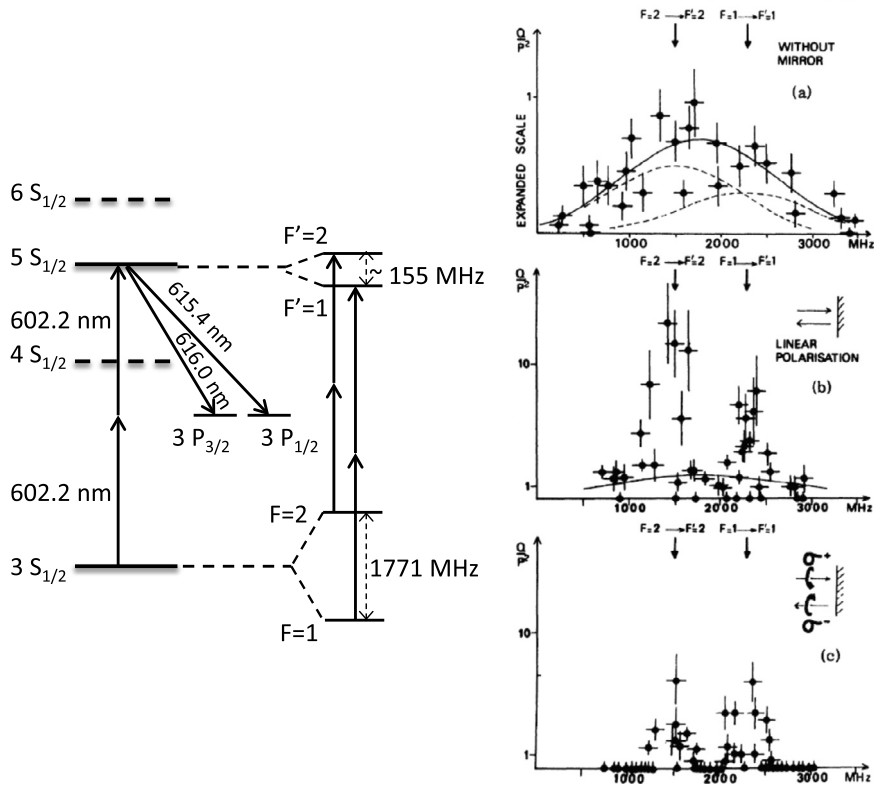

Fig. 3. On the left: energy levels of sodium involved in the 3S–5S two-photon transition. On the right: the first signal observed in Paris [10].

publish the principle of the method in an article in French in the *Journal de Physique*, with the hope of keeping the idea still relatively secret [9].

In spite of this disappointment, Cagnac was strongly motivated to carry out the experiment. He chose to try to observe the two-photon transition between the $3S_{1/2}$ and $5S_{1/2}$ levels in sodium. The advantage was that the required wavelength was obtained with a Rhodamine 6 G dye laser. This laser would be both powerful and with a small line width. After a long search, Cagnac selected a flashlamp-pumped dye laser which had the right specifications: laser pulse with a 1 kW power, a 10 Hz repetition rate, and a line width smaller than 8 MHz. In fact, the best results obtained after one year of work were the following: pulse power varying from 0 to 0.3 kW, repetition rate of 0.1 Hz, and spectral width of about 250 MHz. In these conditions, the observation of the two-photon transition was a true challenge. A significant difficulty was the control and the measurement of the laser frequency, which varied from one laser pulse to the next. To adjust the wavelength of the laser to the two-photon transition, we used a monochromator with a resolution of 15 GHz and a Fabry–Perot interferometer. To control the fluctuations of the laser frequency, Cagnac modified this monochromator to use two output slits, one centered on the wavelength $\lambda_0 - \epsilon$, and the other on $\lambda_0 + \epsilon$. When the laser wavelength was λ_0 , the signals obtained after the two slits were identical, independently of the laser pulse intensity. The problem of the irreproducibility of the laser pulses was thus overcome. Instead of recording the intensity after one slit, we measured the ratio of the intensities after the two slits. Finally the measurement of the small variations of the laser frequency was made with a Michelson interferometer. Eventually, in spite of the imperfections of our laser, we succeeded in observing the 3S–5S two-photon transition in December 1973.

2. The first Doppler-free two-photon experiments

The first experimental demonstrations of Doppler-free two-photon spectroscopy were performed in rapid succession in Paris [10] and at Harvard [11] on the 3S–5S transition in sodium. These first two experiments used a pulsed dye laser. Fig. 3 illustrates the results of the Paris experiment. The flashlamp-pumped dye laser produced a wavelength at 622.2 nm to excite the sodium atom from the $3S_{1/2}$ level to the $5S_{1/2}$ level. This excitation was detected by observing the fluorescence from the $5S_{1/2}$ level to the $3P_{1/2}$ and $3P_{3/2}$ levels. The $3S_{1/2}$ and $5S_{1/2}$ levels are split into two $F = 1$ and $F = 2$ hyperfine levels, and, because of the selection rule $\Delta F = 0$, the two-photon transition is split into only two components (between two S levels, the transitions $\Delta F = +1$ and $\Delta F = -1$ are not allowed by the electromagnetic rules). The right half of Fig. 3 shows the experimental results. In (a), the atoms interact with only one traveling wave, so the excitation is not Doppler free. In (b), the atoms are placed in a linearly polarized standing wave. Two peaks corresponding to the Doppler-free excitation of the two hyperfine components $F = 1 \rightarrow F' = 1$ and $F = 2 \rightarrow F' = 2$ appear. In (c), the two counterpropagating waves are

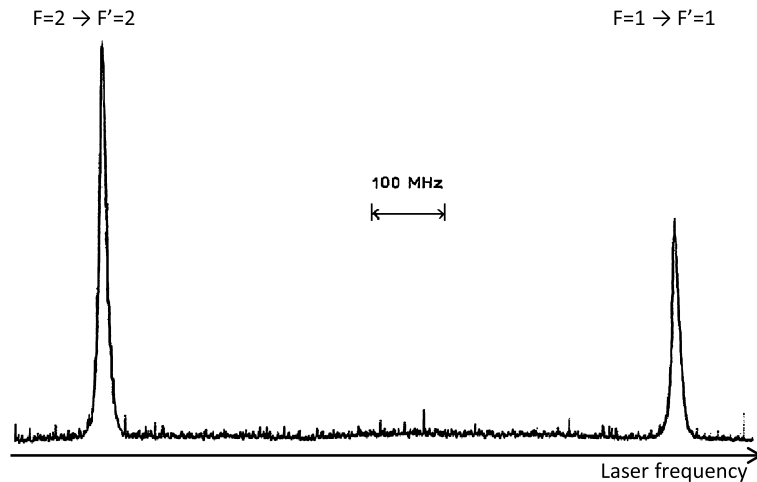

Fig. 4. Recording of the 3S–5S two-photon transition with a CW dye laser. The two peaks correspond respectively to the $F = 1 \rightarrow F' = 1$ and $F = 2 \rightarrow F' = 2$ hyperfine components (figure from the reference [13]).

polarized in σ^+ and σ^- . In this case, the atom must absorb a photon from each wave, since the absorption of two photons σ^+ or two photons σ^- is forbidden. Using this configuration, the Doppler background is eliminated. In Fig. 3, the dispersion of the experimental points was explained by the irreproducibility of the intensity and frequency of the laser pulses.

Very quickly, it appeared that the two-photon excitation was possible with a CW (continuous wave) single-frequency laser. In 1974 T.W. Hänsch and A.L. Schawlow observed the 3S–4D two-photon transition in sodium with an excellent signal-to-noise ratio [12]. To illustrate this improvement, Fig. 4 shows a recording of the same transitions as those of Fig. 3 made with a CW dye laser. From this moment on, a lot of results were obtained on the sodium atom to study the Zeeman and the Paschen–Back effect of the 3S–4D transition or to measure the fine or hyperfine structures of the 4D and 5S levels [14–17]. These first experiments showed the potential of the Doppler free two-photon spectroscopy. In 1975, Élisabeth Giacobino joined our group to participate in the study of the broadening and the shift of the 3S–5S and 3S–4D transitions in sodium due to the collisions with the rare gases [18] and to the spectroscopy of the neon atom [19]. For this last experiment, we used for the first time a build-up cavity to increase the laser intensity seen by the atoms. At this time, the Doppler-free two-photon spectroscopy was also applied to the study of the Rydberg states of potassium and rubidium [20,21]. More details on these experiments can be found in reference [22].

In the next period, thanks to the increase of laser power and the reduction of laser linewidth, we were able to use two-photon spectroscopy to make absolute measurements of atomic energy levels with a very high precision. For instance, the method was applied to determine the frequency of the $2^3S_1-2^3D_1$ two-photon transition in helium and deduce the Lamb shift of the 2^3S_1 metastable state [23]. Another example is the development of a standard laser using a diode laser at 778 nm stabilized on the $5S_{1/2}-5D_{5/2}$ two-photon transition of rubidium. This transition is probably one of the more intense two-photon transitions because the laser frequency is close to resonance with the strong $5S_{1/2}-5P_{1/2}$ and $5S_{1/2}-5P_{3/2}$ resonance lines at 795 nm and 780 nm. For this reason, we used this transition at the beginning of the 1980s to observe the two-photon optical bistability that appears when the rubidium cell is placed inside an enhancement cavity [24]. Later, as this transition is very close to the 2S–8D transition in hydrogen (see the next section), we developed this standard laser whose performance turned out to be about ten times better than that of the well-established iodine-stabilized He–Ne laser [25]. Then, in a fruitful collaboration with the group of André Clairon at the “Laboratoire primaire du temps et des fréquences” (Observatoire de Paris), the frequency of this standard was determined with an uncertainty of 2 kHz, corresponding to a relative uncertainty of 5.2×10^{-12} [26]. This work was made possible thanks to a 3-km-long optical fiber placed underground between our laboratory and the “Observatoire de Paris”, fiber that was obtained after several years of effort and thanks to the tenacity of Bernard Cagnac. This opened up the possibility to transfer optical frequencies between our two laboratories [27], an approach now used widely.

Nevertheless, the main application of two-photon spectroscopy to very high precision measurements has been the study of atomic hydrogen.

3. Two-photon spectroscopy of the hydrogen atom

Hydrogen is the simplest atom, comprising only a proton and an electron. It has played a key role in testing fundamental theories, and hydrogen spectroscopy is associated with successive advances in the understanding of the atomic structure. Fig. 5 shows the energy levels of hydrogen for different steps of the theory. The solution to the Schrödinger equation gives the same energy levels as the simple Bohr model. The energy E_n depends only on the principal quantum number n :

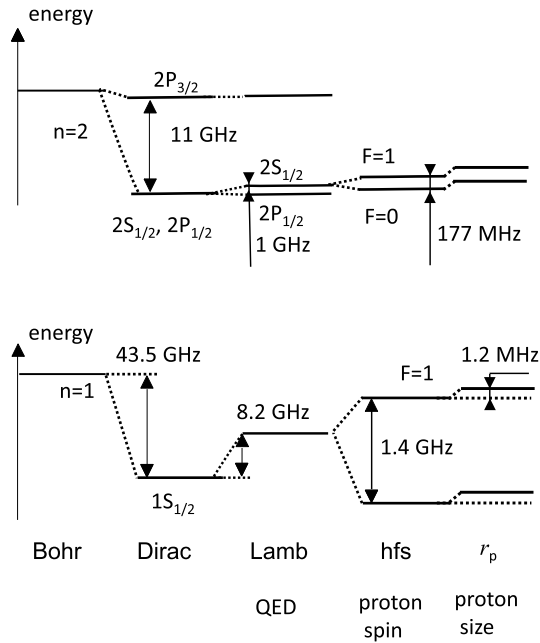

Fig. 5. The successive steps of the theory for the $n = 1$ and $n = 2$ hydrogen levels.

$$E_n = -\frac{hcR_\infty}{n^2} \tag{3}$$

The Rydberg constant R_∞ is known as a function of the fine-structure constant α , of the speed of light c , of the Planck constant h and of the electron mass m_e :

$$R_\infty = \frac{\alpha^2 m_e c}{2h} \tag{4}$$

This equation which links several fundamental constants is very useful for the adjustment of the fundamental constants.

The next step of the theory takes into account the relativistic corrections that are given by the Dirac equation. This equation lifts the degeneracy in j (j is the total angular momentum: $j = l \pm 1/2$) and explains the fine structure, but, for instance, leaves the levels $2S_{1/2}$ and $2P_{1/2}$ degenerate. This degeneracy disappears with the corrections due to quantum electrodynamics (QED), which are responsible for the Lamb shift between the $2S_{1/2}$ and $2P_{1/2}$ levels, first observed by Lamb and Retherford in 1947 [28]. The main QED corrections are the self energy (SE), which corresponds to the emission and reabsorption of virtual photons by the electron, and the vacuum polarization (VP), which is due to the creation of virtual electron-positron pairs. A simple explanation of the self energy is given by the Welton model [29]. Because of the zero-point energy of the modes of the electromagnetic field (the energy $\hbar\omega/2$ of the harmonic oscillators), the electron is subjected to the fluctuations of the vacuum field, which induce fluctuations in its position. This effect modifies the Coulomb potential experienced by the electron and is particularly large for the S levels: it reduces the binding energy, i.e. it increases slightly the energy of the S states ($l = 0$), because, for the S states, the electron has a large probability $|\Psi(0)|^2$ of being inside the nucleus. For the $2S_{1/2}$ level, this shift is about 1045 MHz. The $2P_{1/2}$ is also downshifted by about 13 MHz due to vacuum polarization. This is the reason for the 1058 MHz splitting between the $2S_{1/2}$ and $2P_{1/2}$ levels (see Fig. 5). The Lamb shift follows approximately a $1/n^3$ scaling law with respect to the principal quantum number n and, consequently, the Lamb shift of the 1S level is about 8 GHz. The Lamb shift also includes the effect of the non-zero size of the nucleus, which follows the same $1/n^3$ scaling law. This effect produces a shift of the 1S level of about 1 MHz. The calculation of the Lamb shift $L_{n,l,j}$ is, to put it mildly, very difficult. It is obtained as a series of terms in powers of α , $Z\alpha$ (Ze is the charge of the nucleus and $Z\alpha$ characterizes the interaction between the proton and the electron), m_e/m_p and the root-mean-square charge radius of the proton r_p . A very clear review of these different terms is given in reference [30].

Fig. 6 shows the main two-photon transitions observed in the hydrogen atom. The first was the 1S–2S transition. The idea to apply the two-photon spectroscopy to this transition was immediately proposed by several authors, Cagnac et al. [9], Baklanov and Chebotayev [31], and Hänsch et al. [12]. It was a very attractive proposal: because of the very small natural width (1.3 Hz) of the 2S level, the quality factor of the 1S–2S transition is about 2×10^{15} . However, it was experimentally very difficult, due to the UV wavelength of this transition (243 nm), which is produced by a frequency doubling of a 486 nm wavelength in a nonlinear crystal. Moreover, the two-photon transition probability is very low because there is no intermediate level between the 1S and 2S levels. Since the first observation by Hänsch et al. in 1975 [32], the 1S–2S transition has been studied by several other groups in Southampton [33], Oxford [34], Yale [35], and MIT [36]. The 1S–2S

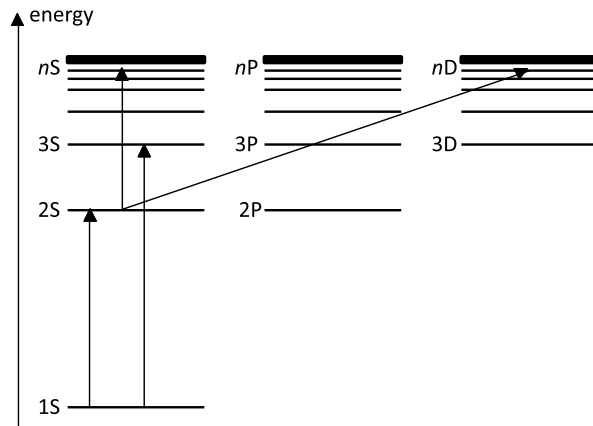

Fig. 6. Main two-photon transitions observed in hydrogen. The 1S–2S transition has been principally studied at Stanford and in Garching by the group of Hänsch. The 1S–3S transition is currently studied in Garching and Paris. The 2S–nS/D transitions have been studied in Paris.

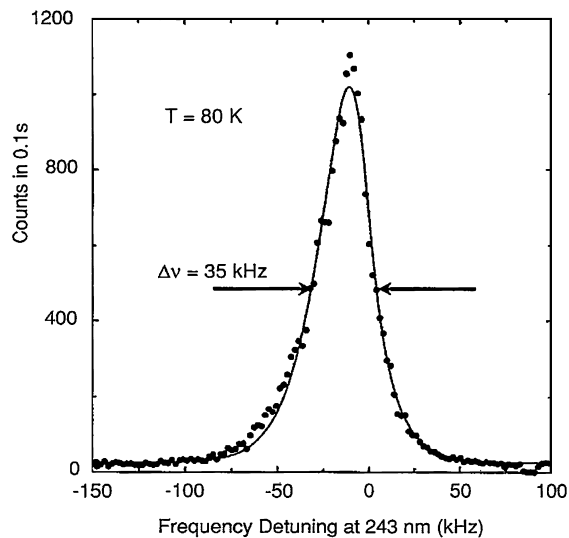

Fig. 7. Line shape of the 1S–2S two-photon transition observed in 1992 by Hänsch and coworkers [42]. The asymmetry of the line is due to the second-order Doppler effect. The 1S–2S frequency was determined with an uncertainty of 45 kHz (courtesy of T.W. Hänsch, copyright 1992 by the American Physical Society).

transition has been also observed in other hydrogenic systems, namely positronium [37–39] and muonium [40]. The theory of these systems, comprised entirely of leptons, respectively by a positron and an electron (e^+e^-) and by a muon and an electron (μ^+e^-), avoids the difficulty of the proton structure in hydrogen. Nevertheless, the relatively short lifetime of these systems has limited the accuracies of the best frequency measurements to a few megahertz, which is not competitive with that obtained in hydrogen.

On the 1S–2S transition, the most important work has been performed by the group of Hänsch, who has continuously studied this transition since these first observations. An important step was the observation of the 1S–2S transition with a CW source [41]. In a long series of experiments, Hänsch improved the precision on the measurement of the 1S–2S frequency. For instance, the observed linewidth of the 1S–2S transition was reduced from about 100 MHz in 1975 [32] to 8 MHz in 1985 [41] and 35 kHz in 1992 (see Fig. 7) [42]. The first determination of the 1S–2S frequency used an interferometric method and the accuracy was limited to a few parts in 10^{-10} . In the 1990s, this limitation was overcome thanks to optical-frequency measurements. In a first experiment, Hänsch used a frequency chain that linked the 1S–2S frequency (about 2466 THz) to a transportable CH_4 -stabilized He–Ne frequency standard at 88 THz [42,43]. Now, this complex frequency chain has been replaced by a femtosecond laser frequency comb, which links in one fell swoop the Cs clock at 9 GHz to the optical frequency. Thanks to this technique, pioneered by Hänsch [44] and J.L. Hall [45], Hänsch’s group has recently succeeded in measuring the 1S–2S interval with respect to a transportable Cs atomic fountain clock from the SYRTE (formerly “Laboratoire primaire du temps et des fréquences”) at the “Observatoire de Paris” [46]. This last measurement reduced the uncertainty to 10 Hz (i.e. a relative uncertainty of about 4.2×10^{-15}).

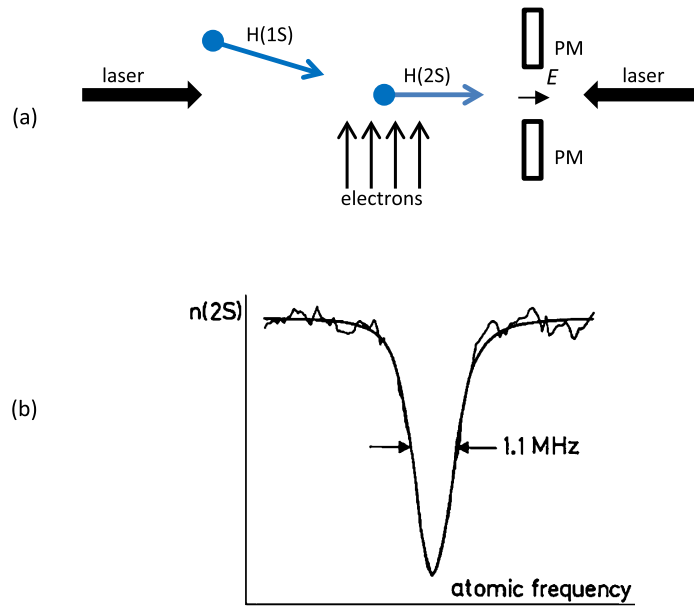

Fig. 8. (a) Geometry of the two-photon excitation for the observation of the $2S-nS/D$ transition. The $2S$ atomic beam is obtained by electronic excitation from a $1S$ atomic beam. At the end of the $2S$ atomic beam an electric field E is applied to quench the $2S$ atoms and detect the Lyman- α fluorescence. Moreover the atomic beam is placed inside a build-up cavity; (b) Recording of the $2S_{1/2}(F=1) - 10D_{5/2}$ two-photon transition in hydrogen, observed as a decrease of the metastable beam intensity $n(2S)$ [59]. The 1.1 MHz linewidth is greater than the 296 kHz natural width. The main cause of signal broadening is the inhomogeneous lightshift that atoms undergo in the laser beams.

The $1S-2S$ transition frequency is approximately the sum of two terms: the first one is roughly $3R_{\infty}c/4$, while the second corresponds to the $1S$ and $2S$ Lamb shifts. Consequently, it is not possible to deduce the values of the Rydberg constant or of the $1S$ Lamb shift from a $1S-2S$ frequency measurement alone. To circumvent this difficulty, Hänsch proposed as early as 1975 to compare the $1S-2S$ and $2S-4P$ frequencies, which are approximately in a ratio of four. This method eliminates the main contribution of the Rydberg constant and then it is possible to deduce the $1S$ Lamb shift. This method was used by other groups [47,35], and, in 1994, by Hänsch to compare the $1S-2S$ and $2S-4S/D$ frequencies [48,49]. This last work was the first opportunity of a collaboration of our group with that of Hänsch to analyse the line shape of the $2S-4S/D$ transitions. In our group, we have also performed an experiment based on the same idea, but this time by comparing the $1S-3S$ and the $2S-6S/D$ frequencies, which are also in a ratio of four [50]. For the observation of the $1S-3S$ transition, the main difficulty was the source in the UV at 205 nm, which was developed by Sophie Bourzeix. For that purpose, we chose to perform two successive frequency doubling stages of the Ti-sapphire radiation at 820 nm used for the $2S-6S/6D$ excitation. The first frequency doubling used a LBO crystal (lithium triborate) and was very efficient [51]. The second doubling step in a BBO crystal (β -barium borate) was far more challenging, and we finally obtained about 1 mW in a quasi-continuous regime [52]. A $1S$ atomic hydrogen beam was built and, with the help of Derek Stacey for one year, the $1S-3S$ transition was observed in 1995. The last three experiments [35,49,50] provided a determination of the $1S$ Lamb shift with an uncertainty of about 50 kHz.

The two-photon transitions between the $2S_{1/2}$ metastable state and the upper nS and nD levels have been mainly studied in Paris. In 1983, with the scientific support of Bernard Cagnac, Lucile Julien and myself began to build an experiment to observe these transitions. By comparison with the $1S-2S$ transition, these transitions presented two advantages. First, to excite the $n \geq 8$ states, the wavelengths of these transitions were within the range 730–778 nm, which, by that time, was easily obtained with a dye laser. The second advantage was that, at the time, the Lamb shift of the $2S_{1/2}$ level was known with an uncertainty of 9 kHz [53], far better than for the $1S$ level. Consequently, as the Lamb shifts of the upper levels are small and can be calculated with the required precision, it was possible to extract a competitive value of the Rydberg constant from these measurements. The first signal was obtained in 1985 [54]. The geometry of the experiment is shown in Fig. 8(a). A metastable hydrogen atomic beam was obtained by electronic excitation of a $1S$ atomic beam. The excitation laser beams were colinear with the metastable atomic beam to reduce the broadening due to the transit time through the laser beams. The two-photon transition was detected by measuring the number of metastable hydrogen atoms at the end of the atomic beam: after the excitation of a $2S$ atom in the nS or nD level, there is a radiative cascade mainly towards the $1S$ state and, consequently, there appears a decrease in the number of metastable atoms at the end of the atomic beam. A typical signal is shown in Fig. 8(b). A detailed study of the line profiles was required to take into account the light shift and the saturation effects and to extrapolate the line position to zero light power.

From then on, the group of Paris undertook a series of experiments of increasing accuracy for the determination of the Rydberg constant. The hydrogen wavelengths were first compared with those of an iodine-stabilized He-Ne laser with

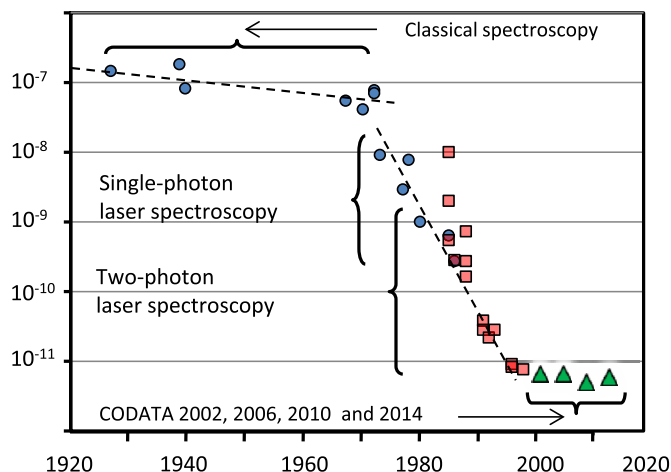

Fig. 9. Relative accuracy on the Rydberg constant from 1920 to the present. Since 1970, there has been a rapid improvement of precision, which is due to laser spectroscopy. Since 2000, there is a stagnation, which is due to the lack of new high-precision measurements in hydrogen. The contribution of single-photon spectroscopy is indicated by the blue circles, the red squares correspond to Doppler-free two-photon spectroscopy, and the green triangles to the CODATA values; classical spectroscopy, from right to left: W.V. Houston [70], D.-Y. Chu [71], J.W. Drinkwater et al. [72], L. Csillag [73], T. Masui [74], E.G. Kessler, Jr. [75] and B.P. Kibble et al. [76]; single-photon laser spectroscopy, from top to bottom: T.W. Hänsch et al. [77], B.W. Petley and K. Morris [78], J.E.M. Goldsmith et al. [79], S.R. Amin et al. [56] and P. Zhao et al. [57,58]; two-photon spectroscopy, from top to bottom: J.R.M. Barr et al. [33], E.A. Hildum et al. [80], D.H. McIntyre et al. [81], F. Biraben et al. [55], M.G. Boshier et al. [34], M.G. Boshier et al. [82], F. Biraben et al. [59], T. Andreae et al. [42], F. Nez et al. [60], M. Weitz et al. [48], F. Nez et al. [61], B. de Beauvoir et al. [62], Th. Udem et al. [43] and C. Schwob et al. [63]; CODATA: 2002 [68], 2006 [83], 2010 [84] and 2014 [30].

an interferometric method. In 1986, the frequencies of the $2S_{1/2}$ – $8D_{5/2}$ transitions in hydrogen and deuterium and of $2S_{1/2}$ – $10D_{5/2}$ transition in hydrogen were measured [55]. The choice of these transitions was a compromise between the linewidths which decrease as n^3 and the parasitic Stark shifts, which increase as n^7 . We deduced a value of the Rydberg constant with a relative uncertainty of 5.5×10^{-10} . This value was two times more precise than the previous result obtained at Yale by W. Lichten, who studied the $2S$ – $3P$ transition (Balmer- α) using a collimated thermal atomic beam [56], but there was a slight disagreement between the two results (about 2σ). By comparison with the Lichten's experiment, the advantage of our experiment was that the natural width of the $8D_{5/2}$ level is about 570 kHz while, for the $3P$ level, it is 30 MHz. In 1986, Lichten published a corrected value of the measurement of the Balmer- α line, which was in perfect agreement with our result and, in 1987, he confirmed this result by studying the Balmer- β transition [57,58]. In Paris, after several improvements of our experiment, the $2S_{1/2}$ – $nD_{5/2}$ transition frequencies were determined for the levels $n = 8, 10$, and 12 in hydrogen and deuterium [59]. The relative accuracy was 1.7×10^{-10} , limited by that of the standard laser (relative uncertainty 1.6×10^{-10}). In 1993, the optical frequencies of the $2S_{1/2}$ – $8S_{1/2}$, $2S_{1/2}$ – $8D_{3/2}$ and $2S_{1/2}$ – $8D_{5/2}$ transitions in hydrogen were measured with a frequency chain using two standard lasers (iodine-stabilized and methane-stabilized helium-neon lasers). The principle of this frequency measurement was that the frequency difference between these two standard lasers was very close to the frequencies of the $2S$ – $8S/D$ transitions. The difficulty was the measurement of a residual frequency difference of 88 GHz. During his Ph.D. thesis, François Nez tried for a long time to bridge this 88 GHz gap with a metal–insulator–metal (MIM) diode before succeeding with a Schottky diode. Finally, the relative uncertainty of these measurements was in the range of 10^{-11} [60,61]. In 1997, the relative uncertainties of these hydrogen frequencies were further reduced, to below one part in 10^{11} [62], thanks to the optical fiber link with the “Observatoire de Paris” and the new standard at 778 nm stabilized on the $5S$ – $5D$ two-photon transition of rubidium [26]. Eventually, this series of measurements was completed by the one on the $2S$ – $12D$ transitions [63]. A complete report of these experiments is given in reference [64].

Gradually, the determination of the Rydberg constant from these measurements was limited by the uncertainty in the $2S$ Lamb shift. This limitation was surpassed thanks to the theoretical work of Karshenboim, who calculated very precisely the deviation from the $1/n^3$ scaling law of the Lamb shift. Now the linear combination of the $1S$ and $2S$ Lamb shift $L(1S)$ – $8L(2S)$ has been calculated with an uncertainty of only 50 Hz [65,66]. By combining two optical frequency measurements in hydrogen (for instance, the $1S_{1/2}$ – $2S_{1/2}$ and $2S_{1/2}$ – $8D_{5/2}$ transition frequencies), it is then possible to extract together the values of the Rydberg constant and of the Lamb shift. Moreover, thanks to the continuous improvements of the QED calculations (see references [67,68]), which were stimulated by the experimental results of hydrogen spectroscopy, the QED part of the Lamb shift is known with an uncertainty of a few kilohertz. By supposing these calculations exact, it is also possible to obtain, from the value of the $1S$ Lamb shift, a value of the radius of the charge distribution of the proton. This analysis is regularly made every four years by the CODATA TGFC (Task Group on Fundamental Constants of the Committee on Data for Science and Technology). For instance, the 2002 CODATA report gave the value of the radius of the charge distribution of the proton as $r_p = 0.8736(77)$ fm from the analysis of the hydrogen and deuterium spectroscopic measurements [68]. At this

time, this value was in agreement with the one deduced from electron–proton scattering experiments ($r_p = 0.895(18)$ fm [69]).

To conclude this review of the first years of Doppler-free two-photon spectroscopy of the hydrogen atom, Fig. 9 shows the reduction of the uncertainty on the Rydberg constant in the last century. Since the beginning of the 1970s, and for three decades, there has been a rapid improvement of the accuracy of the determination of the Rydberg constant by about four orders of magnitude, which was due to the development of laser spectroscopy and more particularly of Doppler-free, two-photon laser spectroscopy.

4. Conclusion

In the first thirty years after its conception, Doppler-free two-photon spectroscopy has rapidly become widely used. After the first experiments on the sodium atom, the method has been mainly applied to hydrogen spectroscopy. The study of this simple atom has stimulated numerous theoretical progresses and the development of new optical frequency measurement methods. From an experimental point of view, the work in Paris on atomic hydrogen has been stimulated by that of Ted Hänsch's groups, first at Stanford, then in Garching. This work developed in a context where positive competition often turned into collaboration. In 2010, the interest in hydrogen spectroscopy was renewed by the observation at the Paul Scherrer Institute of the 2S–2P transition in muonic hydrogen [85,86]. In muonic hydrogen, the muon lies very close to the proton, because its mass is about 207 times that of the electron. Consequently, the effect of the charge distribution of the proton is proportionally much greater than in hydrogen, and it is possible to deduce very precisely the proton's radius r_p . This value of r_p is an order of magnitude more precise, but about 4% smaller, than the CODATA-recommended value [30]. This disagreement has become known as the proton radius puzzle. To try to solve this discrepancy, several precise frequency measurements have been performed in hydrogen, the 2S–4P transition frequency in Garching [87] and the 1S–3S two-photon transition frequency in Paris and Garching [88,89]. Up to now, the proton puzzle remains unsolved.

Acknowledgements

The author is particularly grateful to Lucile Julien and François Nez, who are the backbone of the hydrogen group in Paris. He is pleased to acknowledge here all the Ph.D. students who worked on the two-photon experiments described in this article: Mario Bassini, Karine Wohrer, Jean-Claude Garreau, Sophie Bourzeix, and Béatrice Chatel (de Beauvoir) as Ph.D. students, Mark D. Plimmer, Ferdinando de Tomasi and Leszek Jozefowski as post-docs, and our colleagues Maria Allegrini, Derek Stacey and Catherine Schwob. The authors are indebted to the people of LNE–SYRTE laboratory for the time reference and constant help during all these years.

References

- [1] M. Goppert-Mayer, Über Elementarakte mit zwei Quantensprüngen, *Ann. Phys.* 9 (3) (1931) 273.
- [2] V. Hughes, L. Grabner, The radio frequency spectrum of Rb^{85}F and Rb^{87}F by the electric field resonance method, *Phys. Rev.* 79 (2) (1950) 314.
- [3] L. Grabner, V. Hughes, Further evidence for a two quantum transition in molecular spectroscopy, *Phys. Rev.* 82 (4) (1951) 561.
- [4] P. Kusch, Some observations of double- and triple-quantum transitions, *Phys. Rev.* 93 (5) (1954) 1022.
- [5] J. Brossel, B. Cagnac, A. Kastler, Résonance magnétique sur des atomes orientés optiquement, *J. Phys. Radium* 15 (1) (1954) 6.
- [6] I.D. Abella, Optical double-photon absorption in cesium vapor, *Phys. Rev. Lett.* 9 (11) (1962) 453.
- [7] G. Grynberg, La découverte des transitions à deux photons sans élargissement Doppler, *Bull. Soc. Fr. Phys.* 110 (1997) 4.
- [8] L.S. Vasilenko, V.P. Chebotayev, A.V. Shishaev, Line shape of two-photon absorption in a standing-wave field in a gas, *JETP Lett.* 12 (3) (1970) 161.
- [9] B. Cagnac, G. Grynberg, F. Biraben, Spectroscopie d'absorption multiphotonique sans effet Doppler, *J. Phys.* 34 (1973) 643.
- [10] F. Biraben, B. Cagnac, G. Grynberg, Experimental evidence of two-photon transition without Doppler broadening, *Phys. Rev. Lett.* 32 (12) (1974) 643.
- [11] M.D. Levenson, N. Bloembergen, Observation of the two-photon absorption without Doppler broadening on the 3S–5S transition in sodium vapor, *Phys. Rev. Lett.* 32 (12) (1974) 645.
- [12] T.W. Hänsch, K.C. Harvey, G. Meisel, A.L. Schawlow, Two-photon spectroscopy of Na 3s–4d without Doppler broadening using a CW dye laser, *Opt. Commun.* 11 (1) (1974) 50.
- [13] F. Biraben, Spectroscopie à deux et trois photons sans élargissement Doppler. Application à l'étude des collisions sodium-gaz rare, Thèse d'État, Université Pierre-et-Marie-Curie, 1977, <https://hal.archives-ouvertes.fr/tel-00011828>.
- [14] F. Biraben, B. Cagnac, G. Grynberg, Effet Zeeman en champ magnétique faible sur une transition S–D du sodium par absorption de deux photons sans élargissement Doppler, *C. r. hebd. séances Acad. sci., Ser. B* 279 (1974) 51.
- [15] F. Biraben, B. Cagnac, G. Grynberg, Paschen-Back effect on the 3S–4D two-photon transition in sodium vapor, *Phys. Lett. A* 48 (6) (1974) 469.
- [16] N. Bloembergen, M.D. Levenson, M.M. Salour, Zeeman effect in the two-photon 3S–5S transition in sodium vapor, *Phys. Rev. Lett.* 32 (16) (1974) 867.
- [17] F. Biraben, B. Cagnac, G. Grynberg, Observation of the 3S–5S two-photon transition in sodium vapor without Doppler broadening, using a CW dye laser, *Phys. Lett. A* 49 (1) (1974) 71.
- [18] F. Biraben, B. Cagnac, E. Giacobino, G. Grynberg, Broadening and shift of the sodium 3S–4D and 3S–5S two-photon lines perturbed by noble gases, *J. Phys. B, At. Mol. Phys.* 10 (12) (1977) 2369.
- [19] E. Giacobino, F. Biraben, G. Grynberg, B. Cagnac, Doppler free two-photon spectroscopy of neon I. Fine structure and hyperfine constants for the 4d' subconfiguration, *J. Phys.* 38 (1977) 623.
- [20] C.D. Harper, M.D. Levenson, Fine structure splitting of high ^2D states of ^{39}K , *Phys. Lett. A* 56 (5) (1976) 361.
- [21] K.C. Harvey, B.P. Stoicheff, Fine structure of the $n^2\text{D}$ series in rubidium near the ionization limit, *Phys. Rev. Lett.* 38 (10) (1977) 537.
- [22] G. Grynberg, B. Cagnac, Doppler-free multiphotonic spectroscopy, *Rep. Prog. Phys.* 40 (1977) 791.
- [23] C. Dorrer, F. Nez, B. de Beauvoir, L. Julien, F. Biraben, Accurate measurement of the 2^3S_1 – 2^3D_1 two-photon transition frequency in helium: determination of the 2^3S_1 Lamb shift, *Phys. Rev. Lett.* 78 (19) (1997) 3658.

- [24] E. Giacobino, M. Devaud, F. Biraben, G. Grynberg, Doppler-free two-photon dispersion and optical bistability in rubidium vapor, *Phys. Rev. Lett.* 45 (6) (1980) 434.
- [25] J.-M. Chartier, L. Robertsson, M. Sommer, J. Tschirnich, V. Navratil, R. Gata, B. Pucek, J. Blabla, J. Smydke, M. Ziegler, V. Zeleny, F. Petru, Z. Vesela, K. Tomanyiczka, E. Banreti, Yu.G. Zakharenko, L.F. Vitushkin, International comparison of iodine-stabilized helium–neon lasers at $\lambda = 633$ nm involving seven laboratories, *Metrologia* 28 (1) (1991) 19.
- [26] D. Touahri, O. Acef, A. Clairon, J.-J. Zondy, R. Felder, L. Hilico, B. de Beauvoir, F. Biraben, F. Nez, Frequency measurement of the $5S_{1/2}(F=3)-5D_{5/2}(F=5)$ two-photon transition in rubidium, *Opt. Commun.* 133 (1997) 471.
- [27] B. de Beauvoir, F. Nez, L. Hilico, L. Julien, F. Biraben, B. Cagnac, J.-J. Zondy, D. Touahri, O. Acef, A. Clairon, Transmission of an optical frequency through a 3 km long optical fiber, *Eur. Phys. J. D* 1 (2) (1998) 227.
- [28] W.E. Lamb Jr., R.C. Retherford, Fine structure of the hydrogen atom by a microwave method, *Phys. Rev.* 72 (3) (1947) 241.
- [29] Th.A. Welton, Some observable effects of the quantum-mechanical fluctuations of the electromagnetic field, *Phys. Rev.* 74 (9) (1948) 1157.
- [30] P. Mohr, D.B. Newell, B.N. Taylor, CODATA recommended values of the fundamental physical constants: 2014, *Rev. Mod. Phys.* 88 (3) (2016) 035009.
- [31] E.V. Baklanov, V.P. Chebotayev, On the precise measurement of the frequency transition $1S - 2S$ of the hydrogen atom, *Opt. Commun.* 12 (3) (1974) 312.
- [32] T.W. Hänsch, S.A. Lee, R. Wallenstein, C. Wieman, Doppler-free two-photon spectroscopy of hydrogen $1S-2S$, *Phys. Rev. Lett.* 34 (6) (1975) 307.
- [33] J.R.M. Barr, J.M. Girkin, J.M. Tolchard, A.I. Ferguson, Interferometric measurement of the $1S_{1/2}-2S_{1/2}$ transition frequency in atomic hydrogen, *Phys. Rev. Lett.* 56 (6) (1986) 580.
- [34] M.G. Boshier, P.E.G. Baird, C.J. Foot, E.A. Hinds, M.D. Plimmer, D.N. Stacey, J.B. Swan, D.A. Tate, D.M. Warrington, G.K. Woodgate, Precision spectroscopy of hydrogen and deuterium, *Nature* 330 (1987) 463.
- [35] D.J. Berkeland, E.A. Hinds, M.G. Boshier, Precise optical measurement of Lamb shift in atomic hydrogen, *Phys. Rev. Lett.* 75 (13) (1995) 2470.
- [36] C.L. Cesar, D.G. Fried, T.C. Killian, A.D. Polcyn, J.C. Sandberg, I.A. Yu, T.J. Greytak, D. Kleppner, J.M. Doyle, Two-photon spectroscopy of trapped atomic hydrogen, *Phys. Rev. Lett.* 77 (2) (1996) 255.
- [37] S. Chu, A.P. Mills Jr., Excitation of the positronium $1^3S_1 \rightarrow 2^3S_1$ two-photon transition, *Phys. Rev. Lett.* 48 (19) (1982) 1333.
- [38] S. Chu, A.P. Mills Jr., J.L. Hall, Measurement of the positronium $1^3S_1 - 2^3S_1$ interval by Doppler-free two-photon spectroscopy, *Phys. Rev. Lett.* 52 (19) (1984) 1689.
- [39] M.S. Fee, S. Chu, A.P. Mills Jr., R.J. Chichester, D.M. Zuckerman, E.D. Shaw, K. Danzmann, Measurement of the positronium $1^3S_1-2^3S_1$ interval by continuous-wave two-photon excitation, *Phys. Rev. A* 48 (1) (1993) 192.
- [40] S. Chu, A.P. Mills Jr., A.G. Yodh, K. Nagamine, Y. Miyake, T. Kuga, Laser excitation of the muonium $1S-2S$ transition, *Phys. Rev. Lett.* 60 (2) (1988) 101.
- [41] C.J. Foot, B. Couillaud, R.G. Beausoleil, T.W. Hänsch, Continuous wave two-photon spectroscopy of the $1S_{1/2}-2S_{1/2}$ transition in hydrogen, *Phys. Rev. Lett.* 54 (17) (1985) 1913.
- [42] T. Andreae, W. Köning, R. Wynands, D. Leibfried, F. Schmidt-Kaler, C. Zimmermann, D. Meschede, T.W. Hänsch, Absolute frequency measurement of the $1S-2S$ transition and a new value of the Rydberg constant, *Phys. Rev. Lett.* 69 (13) (1992) 1923.
- [43] Th. Udem, H. Huber, B. Gross, J. Reichert, M. Prevedelli, M. Weitz, T.W. Hänsch, Phase-coherent measurement of the $1S-2S$ transition frequency with an optical frequency interval divider chain, *Phys. Rev. Lett.* 79 (14) (1997) 2646.
- [44] R. Holzwarth, Th. Udem, T.W. Hänsch, J.C. Knight, W.J. Wadsworth, P.St.J. Russell, Optical frequency synthesizer for precision spectroscopy, *Phys. Rev. Lett.* 85 (11) (2000) 2264.
- [45] S.A. Diddams, D.J. Jones, J. Ye, S.T. Cundiff, J.L. Hall, J.K. Ranka, R.S. Windeler, R. Holzwarth, Th. Udem, T.W. Hänsch, Direct link between microwave and optical frequencies with a 300 THz femtosecond laser comb, *Phys. Rev. Lett.* 84 (22) (2000) 5102.
- [46] C.G. Parthey, A. Matveev, J. Alnis, B. Bernhardt, A. Beyer, R. Holzwarth, A. Maistrou, R. Pohl, K. Predehl, T. Udem, T. Wilken, N. Kolachevsky, M. Abgrall, D. Rovera, C. Salomon, P. Laurent, T.W. Hänsch, Improved measurement of the hydrogen $1S - 2S$ transition frequency, *Phys. Rev. Lett.* 107 (2011) 203001.
- [47] C.D. Thompson, G.H. Woodman, C.J. Foot, P. Hannaford, D.N. Stacey, G.K. Woodgate, A comparison of the frequencies of the $1S-2S$ and $2S-4P$ transitions in atomic hydrogen, *J. Phys. B, At. Mol. Opt. Phys.* 25 (1992) L1.
- [48] M. Weitz, A. Huber, F. Schmidt-Kaler, D. Leibfried, T.W. Hänsch, Precision measurement of the hydrogen and deuterium $1S$ ground state Lamb shift, *Phys. Rev. Lett.* 72 (1994) 328.
- [49] M. Weitz, A. Huber, F. Schmidt-Kaler, D. Leibfried, W. Vassen, C. Zimmermann, K. Pachucki, T.W. Hänsch, L. Julien, F. Biraben, Precision measurement of the $1S$ ground state Lamb shift in atomic hydrogen and deuterium by frequency comparison, *Phys. Rev. A* 52 (4) (1995) 2664.
- [50] S. Bourzeix, B. de Beauvoir, F. Nez, M.D. Plimmer, F. de Tomasi, L. Julien, F. Biraben, D.N. Stacey, High resolution spectroscopy of the hydrogen atom: determination of the $1S$ Lamb shift, *Phys. Rev. Lett.* 76 (3) (1996) 384.
- [51] S. Bourzeix, M.D. Plimmer, F. Nez, L. Julien, F. Biraben, Efficient frequency doubling of a continuous wave titanium: sapphire laser in an external enhancement cavity, *Opt. Commun.* 99 (1993) 89.
- [52] S. Bourzeix, B. de Beauvoir, F. Nez, F. de Tomasi, L. Julien, F. Biraben, Ultra-violet light generation at 205 nm by two frequency doubling steps of a cw titanium-sapphire laser, *Opt. Commun.* 133 (1997) 239.
- [53] S.R. Lundeen, F.M. Pipkin, Measurement of the Lamb shift in hydrogen, $n = 2$, *Phys. Rev. Lett.* 46 (4) (1981) 232.
- [54] F. Biraben, L. Julien, Doppler-free two-photon spectroscopy of hydrogen Rydberg states using a CW laser, *Opt. Commun.* 53 (5) (1985) 319.
- [55] F. Biraben, J.C. Garreau, L. Julien, Determination of the Rydberg constant by Doppler-free two-photon spectroscopy of hydrogen Rydberg states, *Europhys. Lett.* 2 (12) (1986) 925.
- [56] S.R. Amin, C.D. Caldwell, W. Lichten, Crossed-beam spectroscopy of hydrogen: a new value for the Rydberg constant, *Phys. Rev. Lett.* 47 (18) (1981) 1234.
- [57] P. Zhao, W. Lichten, H.P. Layer, J.C. Bergquist, Remeasurement of the Rydberg constant, *Phys. Rev. A* 34 (6) (1986) 5138.
- [58] P. Zhao, W. Lichten, H.P. Layer, J.C. Bergquist, New value of the Rydberg constant from the hydrogen Balmer- β transition, *Phys. Rev. Lett.* 58 (13) (1987) 1293.
- [59] F. Biraben, J.C. Garreau, L. Julien, M. Allegrini, New measurement of the Rydberg constant by two-photon spectroscopy of hydrogen Rydberg states, *Phys. Rev. Lett.* 62 (6) (1989) 621.
- [60] F. Nez, M.D. Plimmer, S. Bourzeix, L. Julien, F. Biraben, R. Felder, O. Acef, J.J. Zondy, P. Laurent, A. Clairon, M. Abed, Y. Millerioux, P. Juncar, Precise frequency measurement of the $2S-8S/8D$ transitions in atomic hydrogen: new determination of the Rydberg constant, *Phys. Rev. Lett.* 69 (16) (1992) 2326.
- [61] F. Nez, M.D. Plimmer, S. Bourzeix, L. Julien, F. Biraben, R. Felder, Y. Millerioux, P. de Natale, First pure frequency measurement of an optical transition in atomic hydrogen: better determination of the Rydberg constant, *Europhys. Lett.* 24 (8) (1993) 635.
- [62] B. de Beauvoir, F. Nez, L. Julien, B. Cagnac, F. Biraben, D. Touahri, L. Hilico, O. Acef, A. Clairon, J.J. Zondy, Absolute frequency measurement of the $2S-8S/D$ transitions in hydrogen and deuterium: new determination of the Rydberg constant, *Phys. Rev. Lett.* 78 (3) (1997) 440.
- [63] C. Schwob, L. Jozefowski, B. de Beauvoir, L. Hilico, F. Nez, L. Julien, F. Biraben, O. Acef, A. Clairon, Optical frequency measurement of the $2S-12D$ transitions in hydrogen and deuterium: Rydberg constant and Lamb shift determinations, *Phys. Rev. Lett.* 82 (25) (1999) 4960.
- [64] B. de Beauvoir, C. Schwob, O. Acef, J.-J. Zondy, L. Jozefowski, L. Hilico, F. Nez, L. Julien, A. Clairon, F. Biraben, Metrology of the hydrogen and deuterium atoms: determination of the Rydberg constant and Lamb shifts, *Eur. Phys. J. D* 12 (2000) 61.

- [65] S.G. Karshenboim, The Lamb shift of the excited S-levels in hydrogen and deuterium atoms, *Z. Phys. D* 39 (1997) 109.
- [66] A. Czarnecki, U.D. Jentschura, K. Pachucki, Calculation of the one- and two-loop Lamb shift for arbitrary excited hydrogenic states, *Phys. Rev. Lett.* 95 (2005) 180404.
- [67] K. Pachucki, Complete two-loop binding corrections to the Lamb shift, *Phys. Rev. Lett.* 72 (20) (1994) 3154.
- [68] P. Mohr, B.N. Taylor, CODATA recommended values of the fundamental physical constants: 2002, *Rev. Mod. Phys.* 77 (2005) 1.
- [69] I. Sick, On the rms-radius of the proton, *Phys. Lett. B* 576 (2003) 62.
- [70] W.V. Houston, A spectroscopic determination of e/m , *Phys. Rev.* 30 (1927) 608.
- [71] D.-Y. Chu, The fine structure of the line $\lambda 4686$ of ionized helium, *Phys. Rev.* 55 (1939) 175.
- [72] J.W. Drinkwater, O. Richardson, W.E. Williams, Determinations of the Rydberg constant, e/m , and the fine structures of H_α and D_α by means of a reflexion echelon, *Proc. R. Soc. A* 174 (1940) 164.
- [73] L. Csillag, Investigations on the Balmer lines of deuterium, *Acta Phys. Acad. Sci. Hung.* 24 (1968) 1.
- [74] T. Masui, A new determination of the Rydberg constant, *NBS Spec. Publ.* 343 (1971) 83.
- [75] E.G. Kessler Jr., Determination of the Rydberg constant from the HeII $n = 3 - 4$ (469-nm) line complex, *Phys. Rev. A* 7 (2) (1973) 408.
- [76] B.P. Kibble, W.R.C. Rowley, R.E. Shawyer, G.W. Series, An experimental determination of the Rydberg constant, *J. Phys. B, At. Mol. Phys.* 6 (1973) 1079.
- [77] T.W. Hänsch, M.H. Nayfeh, A. Lee, S.M. Curry, I.S. Shahin, Precision measurement of the Rydberg constant by laser saturation spectroscopy of the Balmer- α line in hydrogen and deuterium, *Phys. Rev. Lett.* 32 (24) (1974) 1336.
- [78] B.W. Petley, K. Morris, A measurement of the Rydberg constant, *Nature* 279 (1979) 141.
- [79] J.E.M. Goldsmith, E.W. Weber, T.W. Hänsch, New measurement of the Rydberg constant using polarization spectroscopy of H_α , *Phys. Rev. Lett.* 41 (22) (1974) 1525.
- [80] E.A. Hildum, U. Boesl, D.H. McIntyre, R.G. Beausoleil, T.W. Hänsch, Measurement of the 1S-2S frequency in atomic hydrogen, *Phys. Rev. Lett.* 56 (6) (1986) 576.
- [81] D.H. McIntyre, R.G. Beausoleil, C.J. Foot, E.A. Hildum, B. Couillaud, T.W. Hänsch, Continuous-wave measurement of the hydrogen 1S-2S transition frequency, *Phys. Rev. A* 39 (9) (1989) 4591.
- [82] M.G. Boshier, P.E.G. Baird, C.J. Foot, E.A. Hinds, M.D. Plimmer, D.N. Stacey, J.B. Swan, D.A. Tate, D.M. Warrington, G.K. Woodgate, Laser spectroscopy of the 1S-2S transition in hydrogen and deuterium: determination of the 1S Lamb shift and the Rydberg constant, *Phys. Rev. A* 40 (11) (1989) 6169.
- [83] P.J. Mohr, B.N. Taylor, D.B. Newell, CODATA recommended values of the fundamental physical constants: 2006, *Rev. Mod. Phys.* 80 (2008) 633.
- [84] P.J. Mohr, B.N. Taylor, D.B. Newell, CODATA recommended values of the fundamental physical constants: 2010, *Rev. Mod. Phys.* 84 (2012) 1527.
- [85] R. Pohl, A. Antognini, F. Nez, F.D. Amaro, F. Biraben, J.M.R. Cardoso, D.S. Covita, A. Dax, S. Dhawan, L.M.P. Fernandes, A. Giesen, T. Graf, T.W. Hänsch, P. Indelicato, L. Julien, C.-Y. Kao, P. Knowles, E.-O. Le Bigot, Y.-W. Liu, J.A.M. Lopes, L. Ludhova, C.M.B. Monteiro, F. Mulhauser, T. Nebel, P. Rabinowitz, J.M.F. dos Santos, L.A. Schaller, K. Schuhmann, C. Schwob, D. Taqq, J.F.C.A. Veloso, F. Kottmann, The size of the proton, *Nature* 466 (2010) 213.
- [86] A. Antognini, F. Nez, K. Schuhmann, F.D. Amaro, F. Biraben, J.M.R. Cardoso, D.S. Covita, A. Dax, S. Dhawan, M. Diepold, L.M.P. Fernandes, A. Giesen, A.L. Gouvea, T. Graf, T.W. Hänsch, P. Indelicato, L. Julien, C.-Y. Kao, P. Knowles, F. Kottmann, E.-O. Le Bigot, Y.-W. Liu, J.A.M. Lopes, L. Ludhova, C.M.B. Monteiro, F. Mulhauser, T. Nebel, P. Rabinowitz, J.M.F. dos Santos, L.A. Schaller, C. Schwob, D. Taqq, J.F.C.A. Veloso, J. Vogelsang, R. Pohl, Proton structure from the measurement of 2S-2P transition frequencies of muonic hydrogen, *Science* 339 (2013) 417.
- [87] A. Beyer, L. Maisenbacher, A. Matveev, R. Pohl, K. Khabarova, A. Grinin, T. Lamour, D.C. Yost, T.W. Hänsch, N. Kolachevsky, Th. Udem, The Rydberg constant and proton size from atomic hydrogen, *Science* 358 (2017) 79.
- [88] H. Fleurbaey, S. Galtier, S. Thomas, M. Bonnaud, L. Julien, F. Biraben, F. Nez, M. Abgrall, J. Guéna, New measurement of the 1S-3S transition frequency of hydrogen: contribution to the proton charge radius puzzle, *Phys. Rev. Lett.* 120 (2018) 183001.
- [89] D.C. Yost, A. Matveev, A. Grinin, E. Peters, L. Maisenbacher, A. Beyer, R. Pohl, N. Kolachevsky, K. Khabarova, T.W. Hänsch, Th. Udem, Spectroscopy of the hydrogen 1S-3S transition with chirped laser pulses, *Phys. Rev. A* 93 (2016) 042509.