



HAL
open science

**IRRIGATION AND DEPOSIT FEEDING BY THE
LUGWORM ARENICOLA MARINA,
CHARACTERISTICS AND SECONDARY EFFECTS
ON THE ENVIRONMENT. A REVIEW OF
CURRENT KNOWLEDGE**

H U Riisgård, G T Banta

► **To cite this version:**

H U Riisgård, G T Banta. IRRIGATION AND DEPOSIT FEEDING BY THE LUGWORM ARENICOLA MARINA, CHARACTERISTICS AND SECONDARY EFFECTS ON THE ENVIRONMENT. A REVIEW OF CURRENT KNOWLEDGE. *Vie et Milieu / Life & Environment*, 1998, pp.243-257. hal-03173003

HAL Id: hal-03173003

<https://hal.sorbonne-universite.fr/hal-03173003>

Submitted on 18 Mar 2021

HAL is a multi-disciplinary open access archive for the deposit and dissemination of scientific research documents, whether they are published or not. The documents may come from teaching and research institutions in France or abroad, or from public or private research centers.

L'archive ouverte pluridisciplinaire **HAL**, est destinée au dépôt et à la diffusion de documents scientifiques de niveau recherche, publiés ou non, émanant des établissements d'enseignement et de recherche français ou étrangers, des laboratoires publics ou privés.

IRRIGATION AND DEPOSIT FEEDING BY THE LUGWORM *ARENICOLA MARINA*, CHARACTERISTICS AND SECONDARY EFFECTS ON THE ENVIRONMENT. A REVIEW OF CURRENT KNOWLEDGE

H.U. RIISGÅRD*, G.T. BANTA**

* Research Centre for Aquatic Biology (Institute of Biology, Odense University),
Hindsholmvej 11, 5300 Kerteminde, Denmark

** Roskilde University, Department of Life Sciences and Chemistry, PO Box 260, 4000 Roskilde, Denmark

WATER PUMPING
IRRIGATION
DEPOSIT FEEDING
ENERGETICS
REWORKING
BIOTURBATION
NUTRIENT FLUXES

ABSTRACT. – The present review gives a short presentation of current knowledge with main emphasis on recent advances in the understanding of the lugworm *Arenicola marina*'s irrigation pump, food energy requirements and feeding biology as related to bioturbation, nutrient fluxes and other secondary effects on the environment. The lugworm uses little energy (< 5 % of total metabolic output) to pump water through its burrow into the sediment, but it is unlikely that the worm significantly enhances its nutritional intake by filter feeding as it does not filter sufficient water to gain enough nutritional benefit. While *A. marina* is found in a wide range of habitats, its mode of life sets limits on the types of sediments it can inhabit. It is critical for the lugworm to be able to pump water into the feeding pocket to adequately ventilate its burrow and to loosen and feed on sediment particles. There appears to be ample food in most sediments to support the nutritional needs of *A. marina*. These food sources may be dead organic matter and living organisms such as bacteria, microalgae, micro- and meiofauna, but there seems to be an unnecessary dichotomy between microbial and detrital food sources in the ongoing discussion of deposit feeder nutrition. Several food sources are probably utilised by *A. marina*, the balance being shifted depending on what is available in a given environment. *A. marina* is a good example of a "ecosystem engineer" as it profoundly affects both the structure and chemical nature of as well as processes occurring within the sediment. As such *A. marina* plays an important role in affecting both energetics and material fluxes at the sediment-water interface of the habitats in which it lives.

EAU POMPÉE
IRRIGATION
MANGEUR DE DÉPÔTS
FLUX ÉNERGÉTIQUES
BIOTURBATION
FLUX DE NUTRIENTS

RÉSUMÉ. – Les connaissances actuelles sont résumées en présentant plus particulièrement les progrès récents concernant notre compréhension de la pompe d'irrigation, des besoins énergétiques et de la biologie de la nutrition en relation avec la bioturbation, du flux de nutriments et des autres effets secondaires sur l'environnement. L'Arénicole utilise très peu d'énergie (< 5 % de la production métabolique totale) pour pomper l'eau à travers sa galerie creusée dans le sédiment, mais il est peu probable que la filtration contribue beaucoup au budget alimentaire de l'Arénicole. Bien que *A. marina* occupe une grande diversité d'habitats, son mode de vie limite les types de sédiments qu'elle peut occuper. L'Arénicole doit être capable de pomper l'eau dans sa cavité alimentaire pour pouvoir ventiler sa galerie correctement et pouvoir séparer et ingérer les particules sédimentaires. Il existe suffisamment de nourriture dans la plupart des sédiments pour assurer les besoins nutritifs de *A. marina*. Elle peut provenir de débris organiques et d'organismes vivants comme les bactéries, les microalgues, la micro et la méiofaune. Il semble exister une dichotomie non fondée entre une origine microbienne et une origine détritique dans la discussion actuelle sur la nutrition par ingestion de dépôts sédimentaires. Plusieurs sources sont sûrement utilisées par *A. marina*, l'importance de chacune variant suivant la disponibilité dans un environnement donné. *A. marina* est un bon exemple d'« ingénieur de l'écosystème » puisqu'elle modifie profondément non seulement la structure et la nature chimique du sédiment, mais aussi les processus se déroulant dans ce sédiment. Comme tel, *A. marina* joue un rôle important en affectant à la fois les flux énergétiques et les flux de matériel à l'interface sédiment-eau des habitats qu'elle occupe.

INTRODUCTION

The lugworm *Arenicola marina* (L.) is a dominant member of the macrobenthos on lower shore in clean to muddy sand throughout much of its geographic range on North west European coasts from the Arctic to the Mediterranean. The lugworm is found almost everywhere on the tidal flats in the Dutch Wadden Sea where it accounts for about 20% of the benthic biomass. Here the density of adult lugworms is about 20 ind. m⁻², and their numbers usually do not surpass 50 m⁻² (Beukema 1976, Cadée 1976, Dankers & Beukema 1983, Flach 1992). In the sandy parts of the German Wadden sea the density is about 40 lugworms m⁻² (Reise 1985).

Arenicola marina lives in 20 to 40 cm deep J-shaped burrows in the sediment. With its head down the worm ingests sediment, and as a result the sand above sinks downwards forming a funnel. For defecation, the worm moves backwards in the burrow until its tail reaches the surface where it ejects its castings which form a characteristic sand-pile. The burrowing and feeding activities of the worm thus physically stir the sediment causing 'bioturbation' which increases the penetration of oxygen into the otherwise anoxic world below the sediment water-interface (Cadée 1976).

The principal food source of the lugworm is still a point of contention, but generally, the lugworm is regarded as a non-selective subsurface deposit-feeder which is nourished by swallowing relatively large amounts of sediments with low nutritive value.

The pumping activity of the lugworm causes a tail-to-head directed ventilatory water flow through its tube, resulting in an in upward flow of oxygenated water in the sediment in front of the head (Wells 1966, Foster-Smith 1978, Toulmond & Dejours 1994). The irrigation of the burrow by the lugworm, combined with the bioturbation activity, may exert a profound effect on the chemistry (Hüttel 1990) and microbiology (Reichardt 1988) of the sediment, and by this also the nutrient fluxes across the sediment-water interface (Davey *et al.* 1990, Retraubun *et al.* 1996 a & b).

A short presentation of recent advances in the understanding of the lugworm irrigation pump and, the worm's food energy requirement and feeding biology as related to bioturbation, nutrient fluxes and other secondary effects on the environment is the subject of this review of current knowledge.

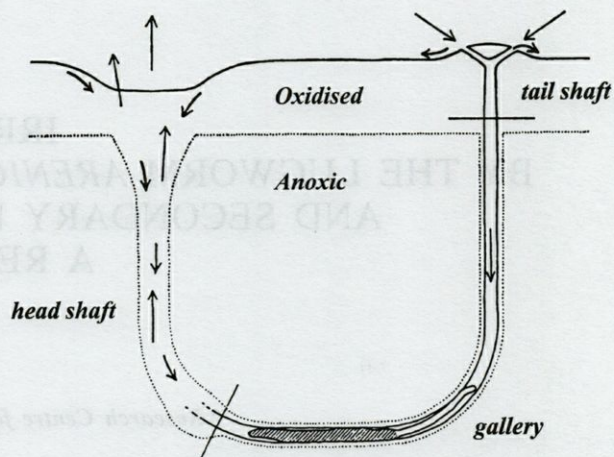

Fig. 1. – Sketch of lugworm in its burrow. The cross lines indicate the boundaries between : head shaft, gallery, and tail shaft. The dotted line indicates the boundary between oxidised yellow sand and anoxic black sand. Long thin arrows indicate direction of water pumped by the worm; short thick arrows show movement of sand ingested by the worm. From Wells (1966).

HOW ARENICOLA MARINA MAKES A LIVING

The older literature on the lugworm way of life was reviewed by Wells (1949 a & b, 1950, 1951, 1961, 1966) and will not be repeated here. In this section a short examination of how *Arenicola marina* makes a living is presented. Normally *A. marina* stays in its burrow, eating the sand and ejecting the familiar sand castings. This is done in a cyclic pattern characterised by the ejection of the faecal cylinders at regular intervals of time. This "normal cyclical pattern (NCP)" may continue uninterrupted for many hours, and the faecal cylinders may gradually build a pile on the sediment surface. The intervals between castings may be about 40 min in large worms and about 15 min in smaller worms. The lugworm feeds in short bursts, each of a few minutes' duration, and each burst is accompanied by a partial inhibition of pumping activity. The pattern of pumping activity has been repeatedly monitored by different workers, most recently by Davey *et al.* (1990) who used thermistors to detect the venting of irrigation water from the lugworm burrow. There is no doubt that the NCP is the worm's regular activity pattern, although it may easily be disturbed in laboratory studies (Wells 1950, Jacobsen 1967).

The lugworm burrow consists of two main parts, the gallery and the head shaft (Fig. 1). The gallery descends from below the pile of faeces. Its walls are impregnated with the worm's secretions, which makes them firm. The worm moves backwards and forwards in the gallery, keeping

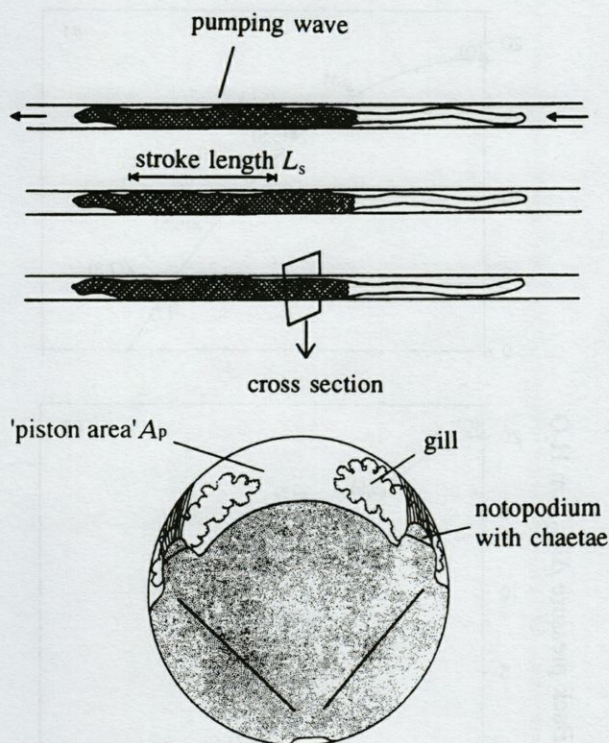

Fig. 2. – *Arenicola marina*. Sketch illustrating the peristaltic waves of contraction and relaxation causing a tail-to-head pumping wave with a stroke length (L_s) defined by the distance between the front of two synchronous 'piston' waves. The 'piston' area (A_p) is defined by the percentage (estimated to 25%) of cross sectional area of the tube not filled up by the worm body. From Riisgård *et al.* (1996).

its head downwards. At the top of the gallery, the burrow narrows to become the tail shaft through which the tail is advanced at the time of defaecation. The head shaft, which is not sealed off by secretions, is a descending column of sand resembling the oxidised surface sand. The worm feeds at the lower end, and here accumulates rejected shell fragments and small stones.

The feeding biology of *Arenicola marina* has been studied and debated for many years (Newell 1948, Krüger 1959, 1962, 1964, Jacobsen 1967, Hobson 1967, Seymour 1971, Hylleberg 1975, De Wilde & Berghuis 1979, Rijken 1979, Pollack 1979, Retraubun *et al.* 1996 a & b), but knowing what the lugworm ingests is not the same as knowing what the worm actually digests and assimilates. The nutritional possibilities seem to be numerous and may be realized in any combination of dead organic matter (detritus) digested directly, bacteria at normal sediment densities or enhanced in abundance externally by 'gardening' in the head shaft which is oxygenated by the worm's irrigation current (Hylleberg 1975) or bacteria may be enhanced in abundance internally (in the hindgut) by microbial fermentation as in rumi-

nants (Plante *et al.* 1989). Furthermore, diatoms, other microphytobenthos and living micro- and meiofauna (ciliates, flagellates, nematodes etc.) small and slow enough to be ingested may serve as food (Hylleberg 1975, Retraubun *et al.* 1996 a & b). According to Krüger (1959) the sediment in front of the worm's head may also be enriched by suspended organic matter 'filtered' from the ventilatory water pumped through the burrow. A precise knowledge of the main nutritional source of the lugworm is still lacking, however, and is a major limitation for a better understanding of this important worm as a subsurface deposit feeder.

The lugworm pumps water through its burrow, in a tail-to-head direction, by means of piston-like waves that run along its dorsal surface (Fig. 2). Most of the water so pumped returns to the surface along the head shaft, although some of it mixes with the surrounding porewater because of porous nature of the sediment in which it lives. The irrigation stream transports oxygen, flushes away soluble excretory products, and may also bring suspended particles that get trapped in the sand at the lower end of the shaft. The pumping of water cause the sand in the head shaft to be more loose and soaked with seawater than the general sand. Because of the oxygenated water stream the walls of the burrow are yellow/brown, in contrast to most of the surrounding black and anoxic sediment. The energy cost of pumping water through a burrow and head shaft into a thick layer of sand that offers a considerable frictional resistance to water flow is dealt with in the following section.

THE LUGWORM PUMP

Referring to Van Dam (1938), Foster-Smith (1978), Baumfalk (1979) and Toulmond & Dejours (1994), the performance of the lugworm pump may decisively deviate from the high-pumping-rate, low-pressure and low-energy pumps which are characteristic of filter-feeding invertebrates (Riisgård & Larsen 1995). This doubt lead Riisgård *et al.* (1996) to make a thorough analysis of the *Arenicola* pump, including an estimate of the energetic costs of pumping. The main findings are presented in the following.

The *Arenicola marina* pump can be considered to be a closed positive displacement pump yielding a constant volume flow (Q) = displacement volume (D_v) multiplied by strokes per unit time (f), or because D_v = stroke length (L_s) multiplied by the 'piston' area (A_p): $Q = D_v f = A_p L_s f$ (Fig. 2). *A. marina* was studied by Riisgård *et al.* (1996) in an observation aquarium and the typical

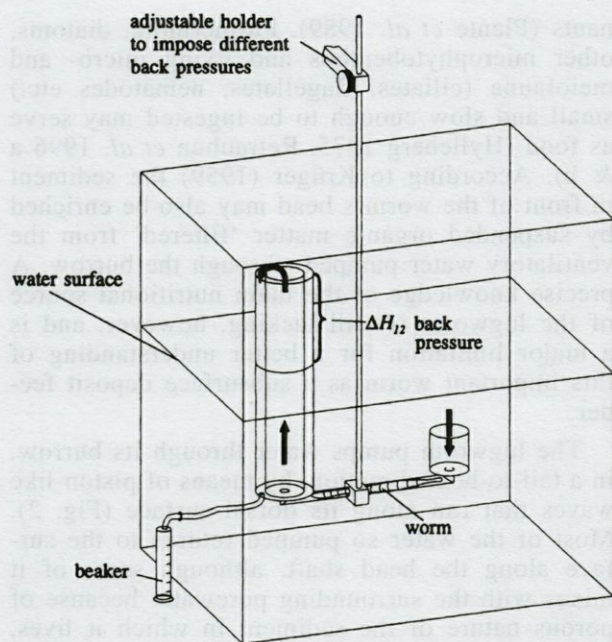

Fig. 3. – Experimental set-up for measurement of pumping rate (= volume flow) at different imposed back pressures for *Arenicola marina*. The arrows indicate direction of water flow caused by the pumping activity of the worm. The collecting device ensured drainage and quantitative collection of the pumped water. From Riisgård *et al.* (1996)

undisturbed stroke frequency of the muscular piston pump was $f_{max} = 7 \text{ strokes min}^{-1}$. Afterwards, a new experimental set-up was used for direct measurement of volume flow at zero and different imposed back-pressures (Fig. 3). The volume flow at zero back pressure ($\Delta H_{12} = 0$) as a function of stroke frequency (f , strokes min^{-1}) was linear as expected from a positive displacement pump, complying with the expression :

$$Q = Q_{op}(f/f_{max}), \quad (1)$$

where Q_{op} = resulting volume flow at the normal operating pressure head (ΔH_{op}). The back pressure characteristic was empirically found to be a non-linear function, the stroke frequency being reduced with increasing imposed back pressure, attaining a maximal pressure head $\Delta H_{12}^0 = 20 \text{ cm H}_2\text{O}$ (Fig. 4). Referring to eq.(1), the back pressure-volume flow characteristic may be modelled by the expression :

$$\Delta H_{12} = \Delta H_{12}^0 [1 - (Q/Q_{op})^2], \quad (2)$$

Curve fits, based on experimental data and eq.(2), show that it is the stroke frequency that controls the volume flow. Thus, the displacement volume (D_v) of the lugworm pump is constant and unaffected by internal leakage flow when the back pressure is increased.

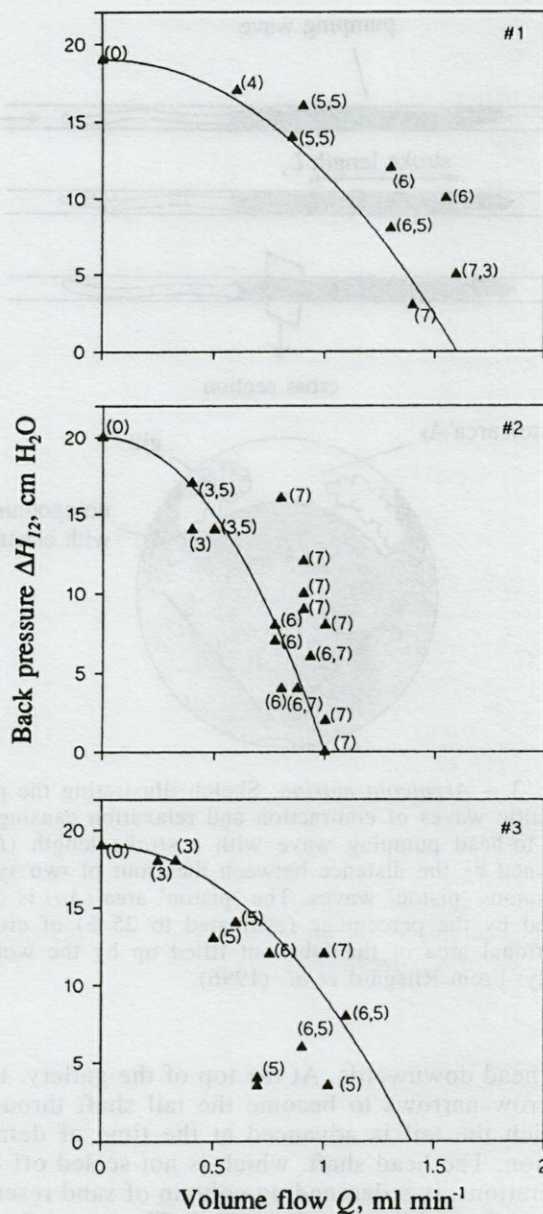

Fig. 4. – *Arenicola marina*. Back pressure pumping rate characteristics in 3 individuals. Stroke frequency (strokes min^{-1}) of the muscular piston pump, recorded simultaneously by direct measurement, is indicated in brackets. Lines were fitted by eq.(2). From Riisgård *et al.* (1996).

Because the pump characteristic, ΔH_p , is determined as the sum of pressure resistance over the pump-system (ΔH_s), and the imposed back pressure (ΔH_{12}), the following expression applies (*cf.* Riisgård & Larsen 1995) :

$$\Delta H_p = \Delta H_s + \Delta H_{12}, \quad (3)$$

or referring to eq.(2)

$$\Delta H_p = \Delta H_s + \Delta H_{12}^0 [1 - (Q/Q_{op})^2]. \quad (4)$$

Table I. – Parameters and performance of ‘standard’ *Arenicola marina* at 15 °C. From Riisgård *et al.* (1996).

Wet weight (W_w , wet wt): 3.5 g
Dry weight (W_d , dry wt): 0.5 g
Stroke frequency (f_{max}): 7 strokes min^{-1}
Volume flow = normal pumping rate ($Q_{op} = Df_{max}$): 1.5 $ml\ min^{-1}$
Maximal pressure rise ($\Delta H_{12}^0 = \Delta H_p^0$): 20 $cm\ H_2O$
Stroke length (L_s): 4 cm
Tube diameter (D): 5 mm
Piston area (A_p): 0.05 cm^2
Displacement volume: $D_v = L_s A_p = 0.20\ ml\ stroke^{-1}$
Normal operating pressure (ΔH_{op}): 5 $cm\ H_2O$
System resistance (ΔH_s): 5 $cm\ H_2O$
Power output (P_p): 12.6 μW
Metabolic rate (R_{tot}): 232 $\mu l\ O_2\ h^{-1} = 1281\ \mu W$
Overall pump efficiency (η): 0.01

The system resistance, which is due to frictional resistance to flow through tube and sediment, is a linear function of flow :

$$\Delta H_s = QC_f, \quad (5)$$

where C_f is a constant. Thus, eq. (3) may be expressed as :

$$\Delta H_p = QC_f + \Delta H_{12}^0 [(1 - (Q/Q_{op}))^2]. \quad (6)$$

From eq. (6), the pumping power-volume flow characteristic of the pump, P_p , may now be obtained as pump pressure ($\rho g \Delta H_p$) multiplied by volume flow (Q) :

$$P_p = \rho g \Delta H_p Q, \quad (7)$$

where ρ = density of seawater and g = acceleration due to gravity.

The total resistance offered by the system (ΔH_s) of the normal active worm pump is due to frictional resistance derived from flow in the tube and through the space between worm body and tube wall, and pressure drop across the sediment in the head shaft. It was calculated by Riisgård *et al.* (1996) that the total head loss of frictional resistance constitute only 0.01 $cm\ H_2O$ in a ‘standard’ *Arenicola marina* pumping 1.5 $ml\ min^{-1}$ (Table I). Thus, the resistance offered by the sediment dominates the total system resistance.

RESISTANCE OF SEDIMENT TO WATER FLOW

The frictional resistance to water flow through the sediment above a pumping lugworm can be estimated by means of Darcy’s law. This empirical law states that the volume flow (Q) is inversely proportional to the thickness (or length (ΔL)) of a core of sediment and directly proportional to

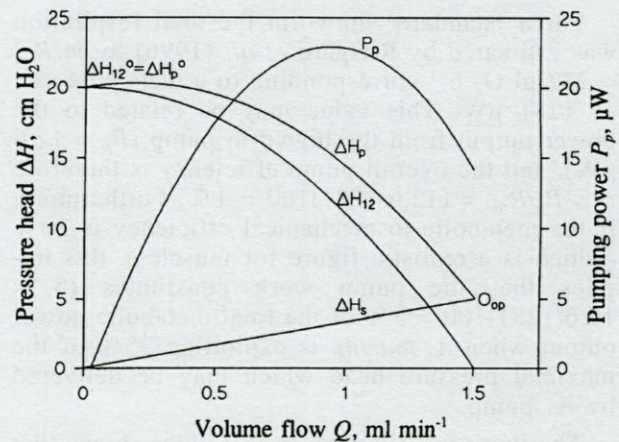

Fig. 5. – *Arenicola marina*. Pressure head-pumping rate characteristics for pump pressure (ΔH_p), system resistance (ΔH_s) and back pressure (ΔH_{12}). P_p : pumping power-pumping rate characteristic of the pump. O_{op} : normal operating point. The calculations are based on a ‘standard’ lug worm, cf. Table I. From Riisgård *et al.* (1996).

the applied pressure (ΔH) and the cross-sectional area of (A) of the core (Riedl 1971, Fetter 1994) :

$$Q = AK\Delta H/\Delta L, \quad (8)$$

where the constant of proportionality (K) is known as the permeability or hydraulic conductivity. The friction caused by water flow in the pore system depends upon the permeability of the sediment and has constant values for each type of deposit. The hydraulic conductivity of rather clean sand from a lugworm habitat was experimentally determined by Riisgård *et al.* (1996) in core samples of different length and diameter to be about $5 \times 10^{-4}\ m\ s^{-1}$.

ENERGY COST OF PUMPING

When the following parameters apply for a ‘standard’ *Arenicola marina* : $\Delta L = 20\ cm$, $A = 5.5\ cm^2$, and $K = 5 \times 10^{-4}\ m\ s^{-1}$ then the ‘system’ resistance of the sediment can be calculated using eq.(8) to be $\Delta H_s \approx 2\ cm\ H_2O$ or 10% of the maximum pressure rise that the lugworm pump may deliver. A realistic upper figure to be experienced by a normal active lugworm in nature may probably be up to 5 $cm\ H_2O$ or 25% of its maximum pressure rise. Therefore, a maximum system resistance of $\Delta H_s = 5\ cm\ H_2O$ may be adopted for further calculations. The curves for the different equations are shown in Fig. 5. At the specified operation pressure ($\Delta H_p = \Delta H_s = 5\ cm\ H_2O$), the power output (P_p) from the ‘standard’ lugworm pump is calculated to be 12.6 μW .

For a 'standard' lugworm the total respiration was estimated by Riisgård *et al.* (1996) to be $R_{tot} = 232 \mu\text{l O}_2 \text{ h}^{-1}$ corresponding to a metabolic rate of $1281 \mu\text{W}$. This value may be related to the power output from the lugworm pump ($P_p = 12.6 \mu\text{W}$), and the overall pump efficiency is therefore $\eta = P_p/R_{tot} = (12.6/1281)100 = 1\%$. Furthermore, if the metabolic to mechanical efficiency is 20% (which is a realistic figure for muscles), this implies that the pump work constitutes $(5 \times 12.6/1281)100 = 5\%$ of the total metabolic power output when *A. marina* is exploiting 25% of the maximal pressure head which may be delivered by its pump.

The work by Riisgård *et al.* (1996) shows that the energy cost of pumping by *Arenicola marina* is modest (< 5%), especially in a loose sediment. On the other hand the powerful pump may at times (presumably over shorter periods) be used for loosening a compact sediment. In this way a high initial system resistance may be reduced to a relatively low value during the normal ventilatory state which is characterized by a steady and continuous stroke frequency of about 7 strokes min^{-1} .

BIOIRRIGATION

Ventilatory pumping by *Arenicola marina* leads to 'bioirrigation' of the sediments it inhabits. Rates of exchange of water (and solutes) between sediment porewaters and the overlying water are enhanced 10- to 20-fold due to irrigation by *A. marina* over what they would be due to diffusive exchange alone (Rasmussen *et al.* 1998). This is a moderate enhancement of water movement typical of bioturbating infauna. In contrast to most other infauna, however, bioirrigation by *A. marina* occurs deep within the sediments and is advective in nature, leading to non-local mixing (*sensu* Boudreau 1984) of overlying water with porewaters surrounding the feeding gallery. The effects of bioirrigation by *A. marina* can be observed as 'flat' porewater profiles flushed of metabolites to depths corresponding to the feeding depths or deeper (Hüttel 1990). In addition, bioirrigation by *A. marina* flushes and oxidizes the sediments to significant depths, thus altering the biogeochemical nature of the environments it inhabits (Nielsen 1997, Banta *et al.* 1998).

BURROWING AND FEEDING

Arenicola marina is an effective burrower, capable of digging several centimetre per minute and establishing its burrow quite quickly in a new area. *A. marina* usually lives at depths of 10 to 40 cm, depending on the size of the individual.

Once established, *A. marina* typically remains in its burrow for long periods of time, moving only if forced to do so because of disturbance or to search for better food resources (Wells 1966, Rijken 1979). Adult *A. marina* change positions occasionally, however, by moving short distances laterally through the sediments (Brey 1991, Flach & Beukema 1994). Both its feeding mode (see below) and how often *A. marina* move depend on the sediment type and food resources available (Rijken 1979, Brey 1991). In contrast to adults, juvenile *A. marina* occasionally migrate over longer distances by swimming, usually during winter (Flach & Beukema 1994).

Arenicola marina is characterized as a head-down, subsurface deposit feeder (Wells 1966). Its most common feeding mode is as a conveyor-belt feeder (*sensu* Rhoads 1974) where sediment is ingested in the feeding gallery at depth and deposited on the sediment surface in faecal cast shortly afterwards. A single worm ingests approximately 1 to 2 ml sediment per hour (see case study below) and has relatively short gut passage times of approximately 1 h (Plante & Mayer 1994). Sediment removed from the feeding gallery is rapidly replaced by sediment above leading to the formation of the feeding funnel. In this way, *A. marina* may ingest sediment and associated materials originating from the sediment surface. While this is the classic feeding pattern, the exact mode of feeding for *A. marina* and the characteristics of the feeding funnel depend on the sediment characteristics, including the sediment structure and organic content (Cadée 1976, Rijken 1979). In some cases there is no identifiable feeding funnel and it appears that *A. marina* feeds on subsurface sediment (Rijken 1979, Brey 1991).

Arenicola marina is not considered a selective feeder in the classic sense (e.g. Lopez & Levinton 1987) of particle selection, although the maximum size particle that can be ingested is ca. 2 mm (Baumfalk 1979). *A. marina* thus preferentially feeds on particles smaller than 2 mm, although below 1 mm it feeds non-selectively (Jones & Jago 1993). This inadvertent selection against larger particles by *A. marina* leads to the establishment of a layer of large particles, often shell fragments, which accumulates at or just below the feeding zone. This 'shell layer' is well known in sediments inhabited by populations of *A. marina* (Van Straaten 1952).

SEDIMENT REWORKING – A CASE STUDY

Recent work by Berntsen & Tarp (unpublished) may serve as a case study for the subject of this section: sediment reworking. The aim of the work

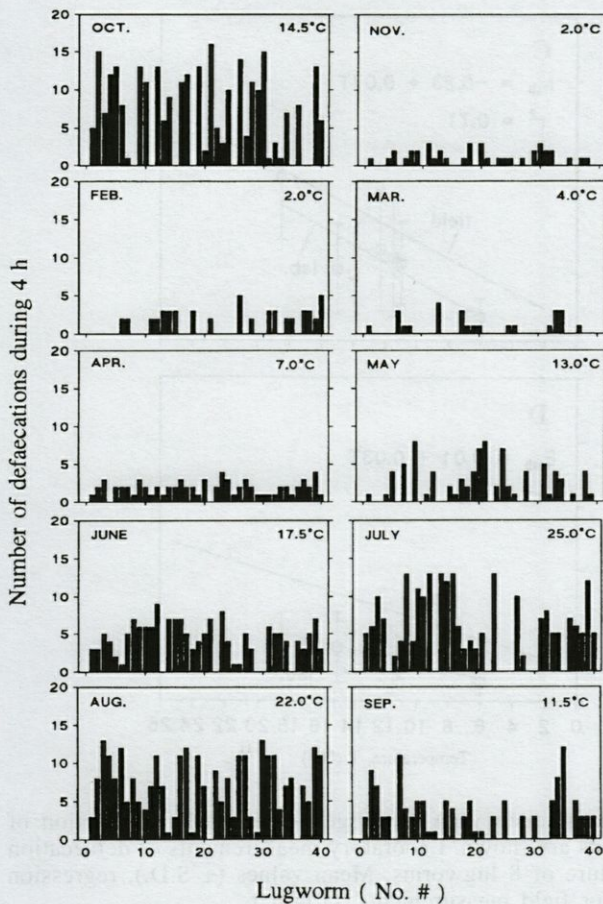

Fig. 6. — *Arenicola marina*. Total number of defaecations during 4 h periods measured on 40 randomly numbered lugworms measured in the field on 10 different times from October 1993 to September 1994. Each bar represents one lugworm. Original.

was to gather field data for the undisturbed feeding activity of *Arenicola marina* because such data are important reference values for prospective studies on feeding and growth of lugworms, and likewise for studies dealing with sediment decomposition processes which may be highly influenced by water pumping and bioturbation.

Population density and defaecation frequency of *Arenicola marina* were measured in Bregnør Bugt, Odense Fjord, Denmark. At low tide an extensive mud flat in the south eastern part of the bay is often laid bare and the sediment surface is seen to be marked by innumerable faecal piles of *A. marina*. Studies on the tidal mud flat were carried out 10 times during the period October 1993 to September 1994. The volume/dry weight ratio of sediment from Bregnør Bugt was measured to be $V = 0.67 \text{ cm}^3 \text{ g}^{-1}$ dry wt.

The egestion rate was quantified on the basis of the total amount of faeces delivered at the sediment surface during 4 h by the lugworms, and the defaecation frequency was estimated as the

number of deliveries per unit of time. At low tide (usually 20 to 50 cm water depth) on calm days without disturbing waves, 40 fresh lugworm faecal piles were marked with numbered sticks before the piles were gently blotted out. During the following 4 h the number of faecal deliveries were measured by counting the number of new faecal strings every 15 min. The faecal strings were sucked up by means of a syringe and transferred to a beaker for determination of dry wt in the laboratory. The population density of lugworms was estimated by counting the number of faecal piles within 10 randomly chosen squares of 1 m^2 .

Corresponding to the field studies the defaecation frequency was measured in the laboratory with lugworms (2 to 4 g wet wt) collected at the field study locality. Individual lugworms were collected by digging up with a spade. The worms were brought to the nearby laboratory where 8 to 10 individuals were placed in an aquarium with sediment and running seawater. Measurements of egestion and defaecation frequency were performed within 1 to 2 days after the worms had established their burrows and started to make faecal piles on the sediment surface.

The frequency of defaecation for the 40 numbered *Arenicola marina* in 10 different months of the year is shown on Fig. 6 with water temperatures measured on the day of examination. There was a pronounced individual variation in the number of defaecations, but it is clear that the activity of the lugworms was highly dependent on season with very low values in the winter months.

The individual defaecation frequency (f , castings h^{-1}) and egestion rate (E , g dry wt h^{-1}) as a function of water temperature measured during low tide in the different months are shown on Fig. 7 A & B. The regression lines illustrate that both parameters increase with increasing temperature. Correspondingly, the defaecation frequency and egestion rate are shown on Fig. 7 C & D as a function of temperature for lugworms established in sediment in the laboratory. In order to compare the field- and laboratory results the regression lines from the field studies are also indicated. It is seen that the activity was generally reduced in the laboratory.

Fig. 8 shows the population density (estimated by counting casts, cf. Flach & Bruin 1993) during the year. From October to April the population density was approximately 25 lugworms m^{-2} . In May and June the density increased due to the establishment of a new lugworm generation, but later the population density decreased again due to mortality caused by predation and/or competition for food and space.

The following calculations are based on the assumption that the lugworm population consists of uniformly distributed 'standard' 3.5 g-wet-

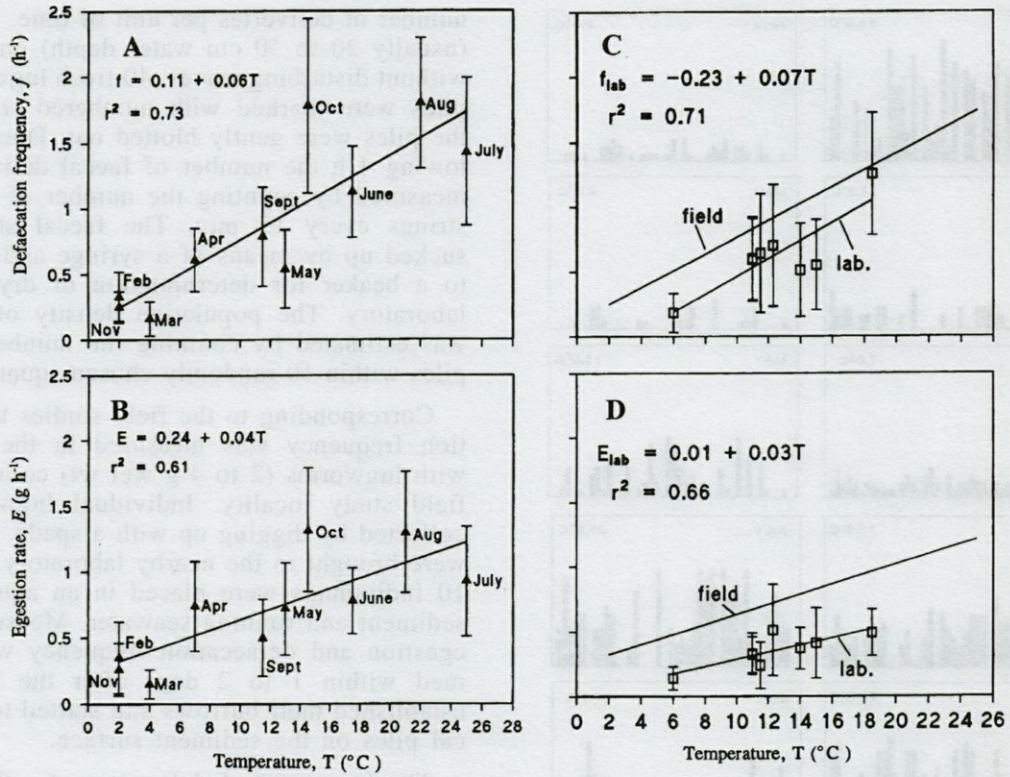

Fig. 7. – *Arenicola marina*. Field measurements of defaecation frequency (A) and egestion rate (B) as function of temperature. Mean values (\pm S.D.), regression lines and equations are shown. Laboratory measurements of defaecation frequency (C) and egestion rate (D) as a function of temperature of 8 lugworms. Mean values (\pm S.D.), regression lines and equations are shown together with the lines found for field measurements. Original.

weight individuals with at density $D = 25$ worms m^{-2} (which is a fairly reasonable assumption in the present case, cf. Fig. 8). The individual egestion at 15 °C may be found from the regression equation shown on Fig. 7 A & B to be : $E = 0.24 + 0.04 \times 15 = 0.84 \text{ g h}^{-1}$. Now, the reworking of sediment may be estimated as : $Rw = (E \times D \times V)/cm^2 = (0.84 \times 25 \times 0.67 \times 720 \text{ cm}^3/\text{month})/10^4 \text{ cm}^2 = 1 \text{ cm month}^{-1} = 12 \text{ cm yr}^{-1}$.

PARTICLE BIOTURBATION

The results of burrowing and sub-surface deposit feeding by *Arenicola marina* is a circular, conveyor belt-like movement of sediment particles. When feeding, sediment particles in the feeding funnel are rapidly drawn (in minutes to hours, Jacobson 1967, Rijken 1979) down to the feeding chamber where they are ingested and returned shortly afterwards to the sediment surface, at a location several cm's away, as faecal casts. This results in burial or subduction of surface sediments (top 10 to 20 cm, depending on the feeding depth) at rates significantly higher than natural sedimentation rates in the environments

inhabited by *A. marina*. The rates of sediment reworking in the case study above yielded sediment burial rates of 12 cm yr^{-1} assuming a standard worm density of 25 m^{-2} (Fig. 8) and an average

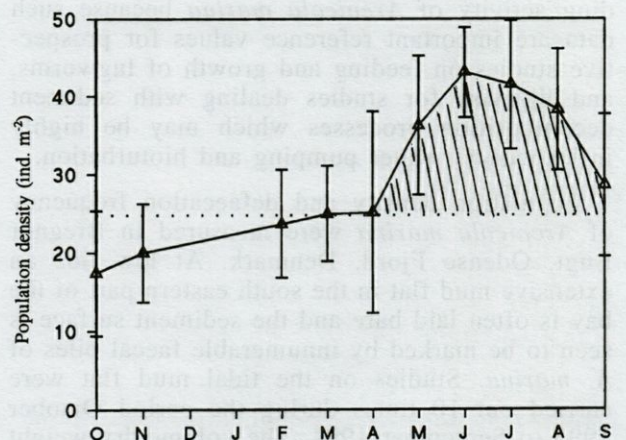

Fig. 8. – *Arenicola marina*. Population density of lugworms at Bregnør Bugt from October 1993 to September 1994. Mean values (\pm S.D.) are indicated. The standard density (25 lugworms m^{-2}) is indicated by the dashed line. The hatched area illustrates a new generation of lugworms. Original.

feeding rate corresponding to 15 °C. Others have estimated rates of subduction due to bioturbation by *A. marina* to be 4 to 40 cm yr⁻¹ (see Table II in Cadée 1976). In contrast, sedimentation rates for most coastal environments are in the range of 0.01 to 1 cm yr⁻¹ (e.g., Berner 1980). Note that these subduction rates are only true for the upper, bioturbated layer where *A. marina* affects particle movement via its feeding and burrowing. True rates of sedimentation, leading to permanent burial under the bioturbated layer, cannot be estimated from feeding rates by *A. marina*, but are probably not significantly affected by the worm. An exception would be in the cases where *A. marina* burrows function as sediment traps (Rijken 1979, Hüttel 1990).

In conclusion, bioturbation by *Arenicola marina* leads to much faster rates (4 to 400 times) of particle movement in the upper layers of sediments they inhabit. This particle bioturbation will be observed first as enhanced rates of burial of surface sediments and ultimately as a homogeneously mixed upper, bioturbated zone of the sediment. At the highest rates of bioturbation, sediment particles in the bioturbated zone will be cycled from the sediment surface, buried and re-surface again several times per year. This represents a significant deviation from the normal mode of particle movement in sedimentary environments, namely unidirectional, slow burial.

FOOD SOURCES AND ENERGY DEMAND

Lack of precise knowledge of the nutritional source is still a major limitation for understanding how *Arenicola marina* makes energetic profit from eating nutritionally-poor sediment despite the fact that it has been a point of discussion for many years (e.g., Krüger 1959, 1971, Jacobson 1967, Longbottom 1970, DeWilde & Berghuis 1979, Rijken 1979, Retraubun *et al.* 1996a). *A. marina* usually lives and feeds in sandy, relatively organic-poor sediments (0.3-3% organic matter, e.g., Cadée 1976, Beukema *et al.* 1983, Brey 1991) where presumably only a fraction of the ingested sediment is digestible (Lopez & Levinton 1987) suggesting that the worm may be organic matter limited. In addition, the worm may be limited in growth by the quality of the food as by its quantity as these low organic matter sediments are of poor nutritional value (high C/N ratio). *A. marina* appears to spend nearly all its time ingesting sediment suggesting that extracting nutrition is a 'full time job'. This is a common characteristic for true deposit-feeders (Lopez & Levinton 1987).

There are several possibilities of food sources for *A. marina*, which may be utilised alone or in combinations: 1) nonliving detrital organic matter (sediment organic matter), 2) bacteria at normal sediment densities, 3) bacteria enhanced in abundance externally by 'gardening' activities, 4) bacteria enhanced in abundance internally by microbial fermentation, 5) bacterial exudates and products, 6) microphytobenthos, 7) living animal matter, 8) dissolved organic material, and 9) suspended organic matter originating from the water column but 'filtered' by *A. marina* (i.e. trapped in the sediment during irrigation).

In the following sections, we attempt to evaluate the importance of most of these potential nutritional sources for *A. marina* based on current knowledge. We use energetic calculations of food demand based on data for metabolic requirement and sediment ingestion rate of a 'standard' *A. marina* as a tool for contributing to this decade-long discussion. The respiration rate of a 'standard' lugworm (3.5 g wet wt) is $R_{tot} = 232 \mu\text{l O}_2 \text{ h}^{-1}$ (Table I). If it is suggested that 1 ml O₂ is used for combustion of 1 mg dry organic matter then the worm demands 0.232 mg assimilated organic matter h⁻¹.

Utilization of sediment detritus

Assuming a feeding rate of 0.84 g sediment dry wt h⁻¹ as observed in our case study, the percentage of total ingested sediment (*I*) which must be digestible organic matter available for the lugworm is: $I/E = (0.232 \times 10^{-3}/0.84)100 = 0.03\%$. This value may be compared to measured concentrations of organic matter in sediments where *A. marina* lives. *A. marina* inhabits sediments ranging widely in organic matter contents, including quite organic-poor sediment. In most cases the sediment organic content is greater than 0.03% suggesting that it is possible for the worm to live as a true deposit feeder, depending on assimilation efficiencies.

There is current discussion of the effectiveness of deposit feeders for extracting dead sediment organic matter (detritus). Part of the difficulty with addressing the use of sediment detritus is that it is difficult to estimate the assimilation of dead organic matter alone, independent of associated microbes. Deposit feeders have been shown to be quite efficient at assimilating sediment microorganisms (Lopez & Levinton 1987). In their review, Lopez & Levinton (1987) argue based on the fact that sediment microbial populations are too small an organic pool for many deposit feeders that some portion of sediment detritus must be utilised by deposit feeders. Furthermore, recent work by Mayer *et al.* (1997) characterising the digestive capabilities of deposit feeders suggests

that *A. marina* is effective at extracting some portion of detrital organic matter. Most deposit feeders assimilate 5 to 15% of the total sediment organic matter (including microbial pools) (Lopez & Levinton 1987). If we apply such assimilation efficiencies to our standard lugworm, then the sediments would have to have an organic content dry weight of 0.2 to 0.6% to support the worm's nutritional needs. This required organic content corresponds quite well with most of the sediments in which *A. marina* lives, suggesting that it could live as a 'pure' deposit feeder in most cases.

Microbial food sources – is 'gardening' necessary?

There is good evidence that *A. marina* is capable of assimilating sediment associated bacteria (Plante & Mayer 1994, Retraubun *et al.* 1996a). In general, deposit feeders assimilate bacteria with high efficiency (40 to 90%, Lopez & Levinton 1987) indicating that they utilize sediment microbes as a food source. But there is not enough microbial biomass to support the nutritional needs of the deposit feeder. For our standard lugworm to live off of 'microbial stripping' alone, sediment microbes would have to have a concentration of 0.03 to 0.1% (as dry wt organic matter) to be a sufficient food source. Bacterial biomass typically is 0.2 to 2% of the total sediment organic matter (measured as C, Rublee 1982, Cammen 1982). Sediments inhabited by *A. marina* would thus have bacterial biomasses (as dry wt organic matter) in the range of 0.001 to 0.1%, which suggests that the lugworm may live by microbial stripping only in the more organic rich (> 1.5% dry wt) sediments. In less organic rich sediments, the standing bacterial biomass is probably not a sufficient food source alone for *A. marina*.

'Gardening', introduced by Hylleberg (1975) has been suggested as a way that lugworms can enhance the availability of microorganisms as a food resource. Briefly, gardening refers to the stimulation of microbial growth due to effects of the lugworm's irrigation and bioturbation on the sediment environment. While this has been a rather controversial subject, there is good evidence that microbial biomass and production is enhanced in the feeding pocket of *Arenicola marina* burrows (Reichardt 1988, Grossmann & Reichardt 1991, Retraubun *et al.* 1996a). Compared to surrounding sediments, bacterial biomass and productivities can be several-fold higher (Reichardt 1988, Retraubun *et al.* 1996a). This process helps expand the range of sediments in which *A. marina* can live exclusively on microbial sources. Microbial gardening would be advantageous for *A. marina* living in organic poor sediments, but has not been shown.

In addition to the classical type microbial gardening, there is evidence that the growth of the bacteria that survive passage through the gut is stimulated in the hind gut of *Arenicola marina* (Plante *et al.* 1989). This mechanism may also play a role in stimulating microbial populations in sediments consumed by *A. marina*. The net effect on the bacterial population depends on the balance between digestion and stimulation, which has not been studied. Several investigators (Grossmann & Reichardt 1991, Retraubun *et al.* 1996a) have measured significant reductions in bacterial numbers upon gut passage indicating bacterial grazing. The surviving bacteria may have very high growth rates (Plante *et al.* 1989), however, leading to a rapid reestablishment of the microbial population. This would be a good example of the kind of renewable resource hypothesized for deposit feeders by Levinton & Lopez (1977). It should be noted, however, that bacteria egested by *A. marina* are deposited on the sediment surface, far away from the feeding zone, so this mechanism of microbial stimulation is probably of little immediate benefit to the lugworm.

Benthic microphytobenthos

Another food source that can be utilised by *Arenicola marina* is benthic microphytobenthos. Similar to sediment microbes, they are readily assimilated by lugworms (Retraubun *et al.* 1996a) and thus a potential food source. Obviously benthic microalgae do not grow at the typical feeding depths of *A. marina*, so a rapid subduction of surface sediments containing microalgae is the only mechanism that would supply this food source in significant numbers. Both correlative (Cadée 1976) and observational (Retraubun *et al.* 1996a) evidence suggests that this occurs. On the other hand, many benthic diatoms are motile, capable of moving several cm per hour (MacIntyre *et al.* 1996) and such motility might allow benthic diatoms to escape feeding by *A. marina*. Retraubun *et al.* (1996a) observed similar concentrations of benthic diatoms in the feeding funnel and head shaft as in the sediment surface suggesting that diatoms were drawn down by lugworms. Furthermore, they observed significant preferential selection of diatoms as a food source. More work is needed to determine to what extent *A. marina* feeds on benthic microphytobenthos and thus functions to some extent as surface deposit feeder.

The nutritional requirements for our standard lugworm living on benthic microalgae would be similar to that of sediment microbes as a sole food source, namely 0.03 to 0.1% dry wt organic matter. Benthic microalgal concentrations of surface sediments ranging between 0.1 and 50 µg chlorophyll *a* g⁻¹ sediment are reported by MacIntyre *et al.* (1996). This corresponds to 4 to 2000 µg

C g⁻¹ sediment or 0.0004-0.2% (ca. 0.0008 – 0.4% dry wt organic matter) assuming a C/chlorophyll *a* ratio of 40 (Valiela 1995), suggesting that only the highest benthic microalgal biomasses could serve as a sole food source for the standard lugworm. But undoubtedly, the benthic microalgae that are present in the sediments ingested by *A. marina* contribute to its diet (Rijken 1979, Retraubun *et al.* 1996).

Micro- and meiofauna consumption

Microfauna and meiofauna both potentially represent high quality sources of nutrition for *A. marina*, although it is unclear to what extent they may be utilised. Hylleberg (1975) observed ciliates and flagellates in the foregut of *Abarenicola pacifica*, a closely related lugworm species, but not in the hindgut and therefore concluded that these organisms were digested. Furthermore, ciliates and flagellate abundances were enhanced in the feeding pocket of this lugworm leading Hylleberg to conclude that this food resource was stimulated as part of the gardening by the lugworm. In contrast, Retraubun *et al.* (1996a) observed only low numbers of meiofauna in the head shaft of *A. marina* and concluded that they could not be an adequate food source. Reise (1985) contends that meiofauna in the feeding pocket are unavailable to the lugworm because they live among the courser particles which cannot be ingested.

While it is unclear to what extent *A. marina* may feed on micro- and meiofauna, we can again consider how much must be consumed by our standard lugworm to be sufficient as a sole food source. Being animals, these are highly digestible food sources, as is corroborated by the absence of such organisms in the posterior sections of lugworm digestive tracts (e.g., Hylleberg 1975). We can thus assume an utilisation efficiency of near 100%. Thus micro- or meiofauna biomasses must be greater than 0.03% (dry wt) to satisfy the needs of the lugworm. Gerlach (1978) estimated that the biomass of ciliates and flagellates, the most important microfauna, to be approximately 1 µg ml⁻¹ sediment, that is, less than 0.0001%. On the other hand, meiofauna (including Foraminifera) biomass was estimated as 70 µg ml⁻¹ or approximately 0.01%. In neither case, are these animals likely to be sufficient as a sole food source for *A. marina*, although meiofauna may contribute significantly to the lugworm's diet.

Filter feeding excluded

It is unknown if or when *Arenicola marina* exploits the full capacity of its pump. The maximal pressure head which can be delivered by the lugworm pump is $\Delta H_p^0 = \Delta H_{12}^0 = 20 \text{ cm H}_2\text{O}$ (Table I, Figs. 4 & 5) which is 30 to 150 times

higher than found in filter-feeding macro-invertebrate pumps (Riisgård & Larsen 1995). The latter group is characterized by pumping large amounts of water per ml of oxygen consumed. Thus, the filter-feeding polychaetes *Sabella penicillus*, *Chaetopterus variopedatus* and *Nereis diversicolor* pump 354, 50 and 40 litres of water per ml of oxygen consumed, respectively (Riisgård & Larsen 1995). These values may be compared with $(1.5 \times 60 \times 10^{-3})/0.232 = 0.4 \text{ l ml}^{-1} \text{ O}_2$ in the 'standard' *A. marina*. This very low value excludes that the lugworm can make a living as a true filter feeder, using the sand immediately in front of the head as a particle retaining filter for restraining suspended food particles in the ventilatory water, as proposed by Krüger (1959, 1962, 1964).

While we can rule out the likelihood of *A. marina* living as a true filter feeder, we do not exclude the possibility that some fraction its nutrition may come from suspended material drawn down into the sediment while irrigating. Especially resuspended material from the sediment surface may represent a potential food source given the high concentration of organic material in such a benthic nepheloid layer, if pumped into and retained within the sediments by *A. marina*. This mechanism has not been investigated to our knowledge.

Summing up, there appears to be ample food in most sediments, from a number of sources, to support the nutritional needs of *Arenicola marina* living as a deposit feeder. These food sources may be dead, detrital organic matter and living organisms such as bacteria, microalgae, micro- and meiofauna. There is an unnecessary dichotomy between microbial and detrital food sources in the ongoing discussion of deposit feeder nutrition (Lopez & Levinton 1987). Several sources are probably utilised by *A. marina*, the balance being shifted depending on what is available in a given environment.

EFFECTS OF *ARENICOLA MARINA* ON THE ENVIRONMENT

Irrigation and oxidation

The irrigation of burrows by benthic polychaete worms exerts a profound effect on the chemistry and microbiology of shallow-water sediments because the burrows extend the sediment-water interface (Fenchel 1996 a & b). Without actively burrowing and irrigating worms, most sediments in estuaries and coastal regions would be anoxic within a depth of a few mm. The infauna worms irrigate their tubes with overlying seawater rich

in oxygen, not only for obtaining oxygen for respiration purposes, but also for producing surrounding oxidised zones which can protect themselves against poisonous sulphide that develops in the anoxic sediment. During irrigation events dissolved nutrients that accumulate in the burrows due to porewater diffusion are transported up into the overlying water. This irrigational transport of dissolved components is much more efficient than the diffusive flux driven by porewater concentration gradients because it is faster than molecular diffusion and because it by-passes the oxidised surface layer of the sediment which acts as a chemical barrier to the upward flux of nutrients. The burrowing worms also physically stir the sediment (bioturbation) which increases the penetration of oxygen so that the upper 2 to 10 cm of the sediment becomes a mosaic of oxic and anoxic microhabitats which enable that anaerobic and aerobic microbial processes may take place at the same depths. The apparent vertical zonation of microbial and chemical processes over a scale of several cm just reflect a diminishing fraction of oxic habitats with depth. The activity of worms has a profound effect on the chemistry of the sediment by extending the surface area of the oxic-anoxic boundary and by importing oxidants (O_2 , NO_3^- , SO_4^{2-}) to deeper layers in the sediment. Irrigation of burrows by benthic worms and increased surface of the oxic/anoxic boundary caused by bioturbation enhances the microbial process rates and thus the nutrient fluxes at the sediment-water interface.

Particle reworking and sediment structure

In addition to affecting sediment chemistry and redox, infauna have profound effects on the physical characteristics of the sediments they inhabit. With *Arenicola marina*, via its intense bioturbation, there is rapid mixing of sediment particles in the layers above the feeding zone. Here sediment particles will be advectively subducted (i.e., buried) due to feeding by *A. marina*. Once a sediment particle reaches the feeding depth it will be returned to the sediment surface, due in the feeding process, if it is small enough. Coarse particles move down wards only (Van Straaten 1952). Depending on the feeding depth, feeding rate and mode of feeding, the upper sediment layer may be turned over several times per year. In this sense, *A. marina* can be considered one of the many infauna organisms functioning as earthworms of coastal areas.

In the area surrounding the feeding gallery, the sediments water content (porosity) is enhanced by *A. marina*'s irrigation (Jones & Jago 1993). Just below the feeding zone, the sediment consists of much larger particles due the accumulation of

rejected large (> 2 mm) particles (Jones & Jago 1993). This leads to the establishment of a 'shell layer' (Van Straaten 1952) if an *A. marina* population has been established for some time.

Effects on other benthic organisms

Macrofauna

The influence of *Arenicola marina* on the abundance of other benthic animals has been studied by Flach (1992) and Flach & Bruin (1993). The lugworm was found to have a strongly negative effect on the densities of the tube-building amphipod *Corophium volutator* and densities of juveniles of various polychaete and bivalve species. This negative effect of adult *A. marina* on juveniles is true for juvenile *A. marina* as well (Flach & Beukema 1994). Similarly, Brey (1991) observed both positive and negative effects of *A. marina* on other macrofauna, although the specific effects varied among habitats. Therefore, the structure of the macrozoobenthic community can be strongly influenced by the density of *A. marina* which is relatively stable in place and time as compared to other infauna species (Beukema *et al.* 1983, Flach & Beukema 1994). The controlling effect of *A. marina* does appear to be dependent on its feeding mode and the stability of the environment (Brey 1991).

Meiofauna

The effects of *A. marina* on meiofauna have been well described by Reise (1981, 1985), among others. Some groups of meiofauna are stimulated by the activities and structures of lugworms while others are inhibited. For example, nematodes numbers are reduced in both the feeding funnel and faecal mounds, while Foraminifera are enhanced in the funnels. The various parts of the lugworm burrow also represent different environmental conditions which enhance meiofaunal populations to various extents, although there is some disagreement as to whether there are distinct groups of meiofauna in lugworm burrows (Reise 1985, Wetzel *et al.* 1995).

Microorganisms

Arenicola marina has both positive and negative effects on sediment microbes. The positive effects can be characterized as the indirect effects of *A. marina*'s burrow structure, mode of feeding and bioturbation which stimulate bacterial growth. In addition, microbes surviving the passage through the gut of a lugworm may also be stimulated (Plante *et al.* 1989). These effects have been seen with other macrofauna (see reviews of Andersen & Kristensen 1991, Krantzberg 1985), although they are strongly evident with lugworms.

The negative effects of *A. marina* are direct, grazing effects. Many researchers (e.g. Grossmann & Reichardt 1991, Plante & Mayer 1994, Retraubun *et al.* 1996) have demonstrated that sediment microbes are consumed by *A. marina*, reducing their biomass, at least immediately. The ultimate effect *A. marina* on sediment microbes is thus a balance of these opposite effects. The general perception is that the overall effect of lugworms is a local stimulation of sediment microbes, despite significant consumption of many.

Effects on material pools and nutrient fluxes

Organic matter decomposition

Macrofauna organisms generally enhance rates of organic matter decomposition (Kristensen & Blackburn 1987). This effect has been poorly studied for *Arenicola marina*. Recent work by Banta *et al.* (1998) confirms the general trend for other macrofauna, that *A. marina* also enhances organic matter decomposition. Organic matter decomposition was enhanced in laboratory microcosms by *A. marina* by 40-125%, depending on the organic matter content of the sediments.

In contrast, *A. marina* had a negative effect on anaerobic decomposition in the study by Banta *et al.* (1998). Thus, while *A. marina* enhances overall organic matter decomposition, it helps favour aerobic processes. This is ecologically important as much of the decomposition ($\geq 50\%$) in marine sediments usually is by anaerobic processes (Mackin & Swider 1989, Jørgensen 1996). Aerobic decomposition thus plays a larger role in organic matter cycling in sediments inhabited by *A. marina* than in other sediments without or with smaller macrofauna. This means that there is a lower production and storage of reduced metabolites than there would be in sediments dominated by anaerobic processes.

Nutrient fluxes and cycling

As an active bioirrigator, *A. marina* enhances the exchange of dissolved materials between sediments and the overlying water. This effect is true for all bioturbating macrofauna, but *A. marina* is especially effective in enhancing the flux of dissolved materials due the mode it irrigates the sediment, namely by advectively pumping water from its burrow out into the porous sediment surrounding the burrow. This pumped water returns to the sediment surface via the feeding funnel in an upwards, advective flow. It is this advective irrigation process that leads to the 'flushed out' porewater nutrient profiles observed in sediments inhabited by *A. marina* (Hüttel 1990, Banta *et al.* 1998). This active irrigation means

that the cycling of dissolved materials is greatly enhanced by *A. marina*, particularly the removal of reduced metabolites (e.g., NH_4^+ , sulfides) from sediments to the overlying water.

In addition to enhancing the exchange of dissolved materials, *A. marina* profoundly affects biogeochemical cycles that are redox dependent. *A. marina* affects the sediment N cycle by stimulating nitrification and subsequently stimulating denitrification which is coupled to nitrification (Hüttel 1990). Similarly, *A. marina* affects sediment S cycling by inhibiting sulfate reduction and rapidly oxidizing reduced S compounds such as dissolved sulfides or pyrite (Banta *et al.* 1998). Thus two of the most important sedimentary element cycles are influenced significantly by the presence of *A. marina*.

CONCLUSIONS

The lugworm *Arenicola marina* is a true sub-surface deposit feeder in organic-poor sediments. *A. marina* lives in tidal and sub-tidal areas consuming sediment organic matter, microorganisms and possibly benthic microalgae. It uses little energy to pump water through its burrow into the sediment, but it is unlikely that the worm significantly enhances its nutritional intake by filter feeding. While *A. marina* is found in a wide range of habitats, its mode of life undoubtedly sets limits on the types of sediments it can inhabit. It is critical for the lugworm to be able to pump water into the feeding pocket to adequately ventilate its burrow and to loosen and feed on sediment particles, and as such it is not found in sediments that are too cohesive. *A. marina* is a good example of a 'ecosystem engineer' as described by Levinton (1995) as it profoundly affects both the structure and chemical nature of as well as processes occurring within the sediment. As such *A. marina* plays an important role in affecting both energetics and material fluxes at the sediment-water interface of the habitats in which it lives.

ACKNOWLEDGEMENTS. – Thanks are due to I. Berntsen and B. Tarp for placing their data ('case study' project supervised by H.U.R.) at our disposal, and to Dr. J. Beukema and Prof. R. Rosenberg for their comments on the manuscript. G. Desportes made the French translation of the English abstract.

LITERATURE CITED

- Andersen FØ, Kristensen E 1991. Effects of burrowing macrofauna on organic matter decomposition in coastal marine sediments. *Symp Zool Soc Lond* 63: 69-88.

- Banta GT, Holmer M, Jensen MH, Kristensen E 1998. The effect of two polychaete worms, *Nereis diversicolor* and *Arenicola marina*, on aerobic and anaerobic decomposition in organic-poor marine sediments. *Acqua Micro Ecol* (submitted).
- Baumfalk YA 1979. On the pumping activity of *Arenicola marina*. *Neth J Sea Res* 13 : 422-427.
- Berner RA 1980. Early diagenesis. A theoretical approach. Princeton University Press, Princeton, NJ, USA.
- Beukema JJ 1976. Biomass and species richness of the macrobenthic animals living on tidal flats in the western part of the Wadden Sea. *Neth J Sea Res* 10 : 236-261.
- Beukema JJ, Cadée GC, Hummel H 1983. Differential variability in time and space of numbers in suspension and deposit feeding benthic species in a tidal flat area. *Oceanol Acta* no SP : 21-26.
- Boudreau BP 1984. On the equivalence of nonlocal and radial-diffusion models of porewater irrigation. *J Mar Res* 42 : 731-735.
- Brey T 1991. The relative significance of biological and physical disturbance: an example from intertidal and subtidal sandy bottom communities. *Est Coast Shelf Sci* 33 : 339-360.
- Cadée GC 1976. Sediment reworking by *Arenicola marina* on tidal flats in the Dutch Wadden sea. *Neth J Sea Res* 10 : 440-460.
- Cammen LM 1982. Effect of particle size on organic content and microbial abundance within four marine sediments. *Mar Ecol Prog Ser* 9 : 273-280.
- Dankers N, Beukema JJ 1983. Distribution patterns of macrozoobenthic species in relation to some environmental factors. In Wolff WJ (ed.) Ecology of the Wadden Sea, Vol. 1, part 4. Balkema, Rotterdam : 69-103.
- Davey JT, Watson PG, Bruce RH, Frickers PE 1990. An instrument for the monitoring and collection of the vented burrow fluids of benthic infauna in sediment microcosms and its application to the polychaetes *Hediste diversicolor* and *Arenicola marina*. *J Exp Mar Biol Ecol* 139 : 135-149.
- De Wilde PAWJ, Berghuis EM 1979. Growth experiments on juvenile lugworms, *Arenicola marina*, in the laboratory. *Neth J Sea Res* 13 : 487-502.
- Fenchel T 1996a. Worm burrows and oxic microniches in marine sediments. 1. Spatial and temporal scales. *Mar Biol* 127 : 289-295.
- Fenchel T 1996b. Worm burrows and oxic microniches in marine sediments. 2. Distribution patterns of ciliated protozoa. *Mar Biol* 127 : 297-301.
- Flach EC (1992) Disturbance of benthic infauna by sediment-reworking activities of the lugworm *Arenicola marina*. *Neth J Sea Res* 30 : 81-89.
- Flach EC, Beukema JJ 1994. Density-governing mechanisms in populations of the lugworm *Arenicola marina* on tidal flats. *Mar Ecol Prog Ser* 115 : 139-149.
- Flach EC, de Bruin W 1993. Effects of *Arenicola marina* and *Cerastoderma edule* on distribution, abundance and population structure of *Corophium voutator* in Gullmarsfjorden, western Sweden. *Sarsia* 78 : 105-118.
- Fetter CW 1994. Applied hydrogeology. MacMillan, New York.
- Foster-Smith RL 1978. An analysis of waterflow in tube living animals. *J Exp Biol Ecol* 34 : 73-95.
- Gerlach SA 1978. Food-chain relationships in subtidal silty sand marine sediments and the role of meiofauna in stimulating bacterial productivity. *Oecologia* 33 : 55-69.
- Grossmann S, Reichardt W 1991. Impact of *Arenicola marina* on bacteria in intertidal sediments. *Mar Ecol Prog Ser* 77 : 85-93.
- Hobson K 1967. The feeding and ecology of two North Pacific *Abarenicola* species (Arenicolidae, Polychaeta). *Biol Bull mar biol Lab*, Woods Hole 133 : 343-354.
- Hüttel M 1990. Influence of the lugworm *Arenicola marina* on porewater nutrient profiles of sand flat sediments. *Mar Ecol Prog Ser* 62 : 241-248.
- Hylleberg J 1975. Selective feeding by *Abarenicola pacifica* with notes on *Abarenicola vagabunda*, and a concept of gardening in lugworms. *Ophelia* 14 : 113-137.
- Jacobsen VH 1967. The feeding of the lugworm *Arenicola marina*. Quantitative studies. *Ophelia* 4 : 91-109.
- Jones SE, Jago CF 1993. In situ assessment of modification of sediment properties by burrowing invertebrates. *Mar Biol* 115 : 133-142.
- Jørgensen BB 1996. Material flux in the sediment. In Jørgensen BB, Richardson K (eds) Eutrophication in Coastal Marine Ecosystems, vol. 52. American Geophysical Union, Washington, DC.
- Krantzberg G 1985. The influence of bioturbation on physical, chemical and biological parameters in aquatic environments: A review. *Env Pollut* 39 : 99-122.
- Kristensen E, Blackburn TH 1987. The fate of organic carbon and nitrogen in experimental marine sediment systems: Influence of bioturbation and anoxia. *J Mar Res* 45 : 231-257.
- Krüger F 1959. Zur Ernährungsphysiologie von *Arenicola marina*. *Zool Anzeiger* 22 : 115-120.
- Krüger F 1962. Experimentelle Untersuchungen zur ökologischen Physiologie von *Arenicola marina*. *Kieler Meeresforsch.* 18 : 157-168.
- Krüger F 1964. Messungen der Pumpfähigkeit von *Arenicola marina* L. im Watt. *Helgoländer wiss Meeresunters* 18 : 70-91.
- Krüger F 1971. Bau und Leben des Wattwurmes *Arenicola marina*. *Helgol wiss Meeresunters* 22 : 149-200.
- Levinton J 1995. Bioturbators as ecosystem engineers: Control of the sediment fabric, inter-individual interactions, and material fluxes. In Jones CG, Lawton JH (eds) Linking Species and Ecosystems. Chapman and Hall, New York.
- Levinton JS, Lopez GR 1977. A model of renewable resources and limitation of deposit-feeding benthic populations. *Oecologia* 31 : 177-190.
- Longbottom MR 1970. The distribution of *Arenicola marina* (L.) with particular reference to the effects of particle size and organic matter of the sediments. *J exp mar Biol Ecol* 5 : 138-157.
- Lopez GR, Levinton JS 1987. Ecology of deposit-feeding animals in marine sediments. *Quart Rev Biol* 62 : 235-260.
- MacIntyre HL, Geider RJ, Miller DC 1996. Microphytobenthos: The ecological role of the "secret garden" of unvegetated, shallow-water marine habitats.

- I. Distribution, abundance and primary production. *Estuaries* 19 : 186-201.
- Mackin JE, Swider KT 1989. Organic matter decomposition pathways and oxygen consumption in coastal marine sediments. *J Mar Res* 47 : 681-716.
- Mayer LM, Schick LL, Self RFL, Jumars PA, Findlay RH, Chen Z, Sampson S 1997. Digestive environments of benthic macroinvertebrate guts : Enzymes, surfactants and dissolved organic matter. *J Mar Res* 55 : 785-812.
- Newell GE 1948. A contribution to our knowledge of the life history of *Arenicola marina*. *J Mar Biol Assoc UK* 27 : 554-580.
- Nielsen OI 1997. Sandormens (*Arenicola marina*) betydning for svovlkredsløbet i tidevandssedimenter. (English title : The lugworm *Arenicola marina*'s importance for the sulfur cycle in intertidal sediments). M.S. Thesis, Institute of Biology, Odense University, Odense, Denmark.
- Plante CJ, Mayer LM 1994. Distribution and efficiency of bacteriolysis in the gut of *Arenicola marina* and three additional deposit feeders. *Mar Ecol Prog Ser* 109 : 183-194.
- Plante CJ, Jumars PA, Baross JA 1989. Rapid bacterial growth in the hindgut of a marine deposit feeder. *Microb Ecol* 18 : 29-44.
- Pollack H 1979. Populationsdynamik, Produktivität und Energiehaushalt des Wattwurms *Arenicola marina* (Annelida, Polychaeta). *Helgol Meeresunters* 32 : 313-358.
- Rasmussen AD, Banta GT, Andersen O 1998. Effects of bioturbation by the lugworm *Arenicola marina* on cadmium uptake and distribution in sandy sediments. *Mar Ecol Prog Ser* 164 : 179-188.
- Reichardt W 1988. Impact of bioturbation of *Arenicola marina* on microbiological parameters in intertidal sediments. *Mar Ecol Prog Ser* 44 : 149-158.
- Reise K 1981. High abundances of small zoobenthos around biogenic structures in tidal sediments of the Wadden Sea. *Helgol Meeresunters* 34 : 413-425.
- Reise K 1985. Tidal flat ecology. Springer-Verlag, Berlin.
- Retraubun ASW, Dawson M, Evans SM 1996a. The role of the burrow funnel in feeding processes in the lugworm *Arenicola marina* (L.). *J Exp Mar Biol Ecol* 202 : 107-118.
- Retraubun ASW, Dawson M, Evans SM 1996b. Spatial and temporal factors affecting sediment turnover by the lugworm *Arenicola marina* (L.). *J Exp Mar Biol Ecol* 202 : 25-35.
- Rhoads DC 1974. Organism-sediment relations on the muddy sea floor. *Oceanogr Mar Biol Ann Rev* 12 : 223-300.
- Riedl R 1971. How much seawater passes through sandy beaches? *Int Revue ges Hydrobiol* 56 : 923-946.
- Riisgård HU, Larsen PS 1995. Filter-feeding in marine macro-invertebrates : pump characteristics, modelling and energy cost. *Biol Rev* 70 : 67-106.
- Riisgård HU, Berntsen I, Tarp B 1996. The lugworm (*Arenicola marina*) pump : characteristics, modelling and energy cost. *Mar Ecol Prog Ser* 138 : 149-156.
- Rijken M 1979. Food and food uptake in *Arenicola marina*. *Neth J Sea Res* 13 : 406-421.
- Rublee PA 1982. Bacteria and microbial distributions in estuarine sediments. In Kennedy VS (ed.) *Estuarine Comparisons*. Academic Press, New York.
- Seymour MK 1971. Burrowing behaviour in the European lugworm *Arenicola marina* (Polychaeta : Arenicolidae). *J Zool*, London 164 : 93-132.
- Toulmond A, Dejours P 1994. Energetics of the ventilatory piston pump of the lugworm, a deposit-feeding polychaete living in a burrow. *Biol Bull* 186 : 213-220.
- Van Dam L 1937. Über die Atembewegungen und das Atemvolumen von Phryganea-Larven, *Arenicola marina* und *Nereis Virens*, sowie über die Sauerstoffausnutzung bei *Anodonta cygnea*, *Arenicola marina* und *Nereis virens*. *Zool Anz* 118 : 122-138.
- Van Straaten LMJU 1952. Biogene textures and the formation of shell beds in the Dutch Wadden Sea. *Proc K Ned Akad Wet (Sect B)* 55 : 500-516.
- Valiela I 1995. Marine ecological processes. 2nd Ed. Springer-Verlag, New York.
- Wells GP 1949a. Respiratory movements of *Arenicola marina* : Intermittent irrigation of the tube, and intermittent aerial respiration. *J Mar Biol Assoc UK* 28 : 447-464.
- Wells GP 1949b. The behaviour of *Arenicola marina* in sand, and the role of spontaneous activity cycles. *J Mar Biol Assoc UK* 29 : 1-44.
- Wells GP 1950. The anatomy of the body wall and appendages in *Arenicola marina* L., *Arenicola clapedii* and *Arenicola ecaudata*. *J Mar Biol Assoc UK* 29 : 1-44.
- Wells GP 1951. The integration of activity cycles in the behaviour of *Arenicola marina*. *J Exp Biol* 28 : 41-50.
- Wells GP 1961. How lugworms move. In Ramsay JA, Wigglesworth VB (eds) *The cell and the organism*. Cambridge : 209-233.
- Wells GP 1966. The lugworm (*Arenicola*) – a study in adaptation. *Neth J Sea Res* 3 : 294-313.
- Wetzel MA, Jensen P, Giere O 1995. Oxygen/sulfide regime and nematode fauna associated with *Arenicola marina* burrows : new insights in the thiobios case. *Mar Biol* 124 : 301-312.

Reçu le 18 juillet 1998; received July 18, 1998
 Accepté le 31 août 1998; accepted August 31, 1998