



HAL
open science

From Procedures, Objects, Actors, Components, Services, to Agents - A Comparative Analysis of the History and Evolution of Programming Abstractions

Jean-Pierre Briot

► **To cite this version:**

Jean-Pierre Briot. From Procedures, Objects, Actors, Components, Services, to Agents - A Comparative Analysis of the History and Evolution of Programming Abstractions. 2021. hal-03482428v2

HAL Id: hal-03482428

<https://hal.sorbonne-universite.fr/hal-03482428v2>

Preprint submitted on 26 Dec 2021 (v2), last revised 13 Jan 2024 (v4)

HAL is a multi-disciplinary open access archive for the deposit and dissemination of scientific research documents, whether they are published or not. The documents may come from teaching and research institutions in France or abroad, or from public or private research centers.

L'archive ouverte pluridisciplinaire **HAL**, est destinée au dépôt et à la diffusion de documents scientifiques de niveau recherche, publiés ou non, émanant des établissements d'enseignement et de recherche français ou étrangers, des laboratoires publics ou privés.

From Procedures, Objects, Actors, Components, Services, to Agents – A Comparative Analysis of the History and Evolution of Programming Abstractions

Jean-Pierre Briot[†]

[†] Sorbonne Université, CNRS, LIP6, F-75005 Paris, France
Jean-Pierre.Briot@lip6.fr

Abstract: The objective of this chapter¹ is to propose some retrospective analysis of the evolution of programming abstractions, from *procedures*, *objects*, *actors*, *components*, *services*, up to *agents*, by replacing them within a general historical perspective. Some common referential with three axes/dimensions is chosen: *action selection* at the level of one entity, *coupling flexibility* between entities, and *abstraction level*. We indeed may observe some continuous quest for higher flexibility (through notions such as *late binding*, or *reification of connections*) and higher level of *abstraction*. Concepts of components, services and agents have some common objectives (notably, *software modularity and reconfigurability*), with multi-agent systems raising further concepts of *autonomy* and *coordination*. notably through the notion of *auto-organization* and the use of *knowledge*. We hope that this analysis helps at highlighting some of the basic forces motivating the progress of programming abstractions and therefore that it may provide some seeds for the reflection about future programming abstractions.

1 Introduction

Object-oriented programming, software components [4] and multi-agent systems [12, 24] are some examples of approaches for software design and development with significant impact. Both offer abstractions for organizing software as a combination of software elements, with a common objective of facilitating its *evolution* (first of all, replacement and addition of elements). In this chapter, our initial objective is to conduct a comparative analysis between *software components* and *multi-agent systems*². In order to better compare them, we replace them within some general *historical perspective* of the *programming evolution* (taking some inspiration from [30]).

There are various comparative studies between *agents* (and multi-agent systems) and, e.g., *objects* [42], *concurrent objects* [29, 30] and *actors* [36]. This article integrates some of these analyzes and complements them the concepts of *components* and of *services*, which, to our knowledge, has not yet been the subject of such systematic comparative studies³. Let us also cite here, for additional information, two comparative analyzes about different component models [20, 37] and about various multi-agent platforms and languages (based on object-oriented, logic or component-based models) [7, 8].

2 Analysis

We have chosen a common conceptual *frame of reference* with *three dimensions* that we consider important issues in programming and software:

- *selection of the action* to be performed by an *entity* – This indicates *when* and *how* a *software*⁴ *entity* will *select* (decide) what *action* to be *performed*, through the activation of a corresponding code. The evolution of programming shows the need for deferring always *later* and *further* this decision (this has been coined as “*ever late binding*”). In addition, for an agent, such a decision may be based, not only on the nature of the invocation, as for classical programming languages, but also on the agent’s own *knowledge* and context (e.g., by its *goals*), in a *proactive* and not only *reactive* manner;

¹This article has been submitted to a project of book about the French school of programming, coordinated by Bertrand Meyer.

²In the following, we will use terms, respectively, *components* and *agents*.

³An initiative on the relations between components and multi-systems agents was the organization in France of two successive editions of Workshop “Journées multi-agents and components” (JMAC) in 2004 and 2006, followed by a journal special issue [6]. Note that this chapter is an adaptation and revision of an original article in french [11].

⁴or physical, in the case of a robot.

- *flexibility of the coupling* between *entities* – This represents the ability to put in *relation* several software *entities*. The evolution of programming shows the need to represent and manipulate such relations independently of the implementation of the entities, in order to favor *dynamicity* as well as the *explicit* manipulation of the relations. The concept of *software architecture* [54], assemblage of components via explicit *connectors*, represents therefore a major advance. The concept of *service* brings further dynamicity (via the concept of *discovery* of services) and *autonomy* for the entity itself (the selection of the actual service(s)). Multi-agent systems bring a step further and higher the reification of the architecture and of the discipline of interaction through the concepts of *organization* and of *interaction protocol*.
- *level of abstraction* – This represents the *expression level* offered to the designer and to the programmer. We can observe a progressive quest for higher-level abstractions, from the initial low-level concepts of *instruction*, to *abstract* concepts of *procedure* and *abstract data types*, which turn out independent of an implementation platform, and finally up to *knowledge* concepts, such as *plan*, *intention*, upon which *automated reasoning* mechanisms can be applied.

It should be noted that these three dimensions are not completely *independent*: action selection may have some impact on coupling flexibility, and the choice of abstractions and mechanisms for action selection and for coupling are clearly related with the level abstraction. In addition, it is possible to consider action selection and coupling uniformly, both based on a single mechanism: *binding*⁵: a) binding of the call to the effective code, in the case of action selection, and b) binding of a link to another entity, in the case of coupling. However, we prefer to *distinguish* them, because their corresponding levels are conceptually distinct (*micro* versus *macro* vision), as well as their corresponding professions (*programmer* versus *system architect*), and their corresponding abstractions and mechanisms (e.g., *agent architecture* versus *interaction protocol*).

3 Action Selection

The first programming languages, e.g., the first version of Fortran, consider program *behavior* (code) and program *state* (data) within a common *global data space*. The different *instructions* are identified through their *line number*. The selection of the action (to be performed) is therefore expressed *globally* and *statically*.

Structured or modular programming languages, such as Pascal and then Modula, bring some *modularization* of the code, expressed under the form of *procedures*. The selection of the action therefore gains in abstraction, the indication of the code to be executed being expressed via a *symbolic name* and no longer by a line number. However, the association of a name of a procedure to its corresponding code remains *static*. In some dual movement, data gradually gains structure and generality, thanks to the concept of *abstract data structures*.

Object-oriented programming languages, with pioneers such as Simula 67 and then Smalltalk, bring some major innovation, through the reunion of some procedures and their associated data into a *self-contained* capsule, named an *object*. Data thus become *internal* and *private* to the object and its procedures (called *methods*) and *message sending* is the only way to invoke an object, which will activate one of its procedures.

Some decisive advance is the discipline of *late binding* such as in Smalltalk, i.e. the procedure to be invoked will be determined according to the *class*⁶ of the actual object invoked, and not according to the declaration of the *type* of the *variable* that references it⁷. This means that the binding of the procedure, and therefore the selection of the action, is delayed at *runtime* and not statically resolved at *compile time*, such as in C++ *early binding* discipline.

Software *components* introduce the concept of “ready to wear, to deploy, and to use”. As opposed to an object, which is orphan and potentially inoperative without its class as well as its parent class (superclass) hierarchy⁸, a component is *self-contained*, with all its code and also its documentation [48]. Therefore, on the contrary of an object, a component does not require any additional external information in order to select and process an action.

The concept of *agent* introduces *internal autonomy* to the selection of the action. It is no more governed only *externally* by the nature of the request, as for a procedure or method call, but also *internally* by the internal state of the agent, or more exactly by its *knowledge*⁹, since this may include be *cognitive* information of the agent such as its own *goals*. Therefore, an agent is no longer only *reactive* (to invocations) like objects, but also *proactive* [42]. Thus, the concept of action selection takes its full meaning, as for a *robot* or a *human* being, who can

⁵See, e.g., [33].

⁶A *class* is the definition of a family of *similar* objects. It is the class that defines the *methods* (procedures) and the *variables* (data model) common to the objects which will be its *instances*, i.e. created by/from it.

⁷We deliberately do not discuss here the relations between *binding* and *typing* (and *sub-typing*), due to the fact that they are subtle and non consensual. For one analysis (among others), see, e.g., [17].

⁸For example, in the case of an object migrating to another site which would not have already loaded its associated class hierarchy.

⁹The *knowledge* of an agent may be defined as what an agent *knows* about its *world* (including itself and other agents), this information being described through *interpretable concepts* (i.e., with the potential to be able to *reason* about them).

<i>Programming</i>	<i>Monolithic</i> <i>ex: Fortran</i>	<i>Modular</i> <i>ex: Pascal</i>	<i>Object-oriented</i> <i>ex: Java</i>	<i>Agent-Oriented</i> <i>ex: AgentSpeak</i>
<i>Behavior</i>	Global	Modular	Modular	Modular
<i>State</i>	Global	Modular and external	Modular and internal	Modular and internal
<i>Invocation</i> (<i>and Selection</i>)	Global and static (<i>goto</i>)	External and static (<i>procedure</i> <i>call</i>)	External and dynamic (<i>method</i> <i>call</i>)	Internal and external and dynamic (<i>ex: goal-</i> <i>driven</i>)

Table 1: Structure of entities and action selection

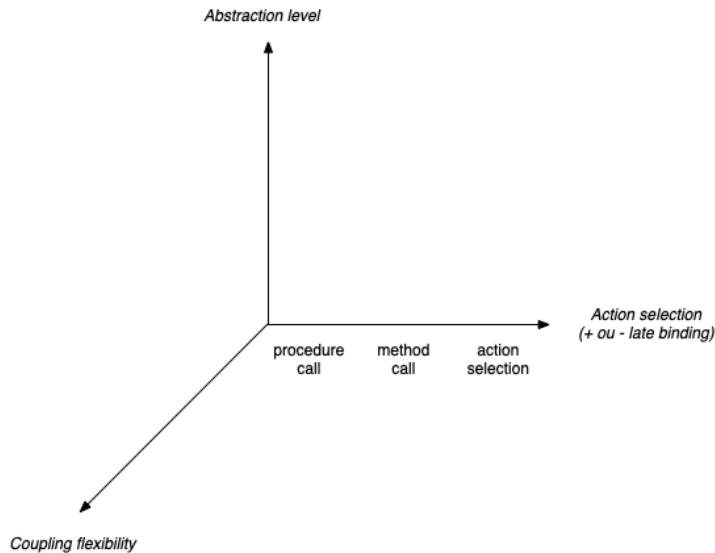

Figure 1: Evolution of action selection

arbitrate his own action(s) at any given time, depending on both its own *objectives* and on information collected (messages from other agents or/and *perceptions* of the *environment*). *Arbitration* can be done at a symbolic level in *cognitive agents*, e.g., according to the agent *intentions*, in an architecture such as BDI [32]. *Reactive agents* have much simpler, *stimulus*-based action response mechanism, close to message response mechanism in object-oriented programming. Note that there is in fact some continuum between *cognitive* and *reactive* agents categories, with hybrid architectures attempting at reconciling and combining the two approaches (see, e.g., the InteRRaP hybrid architecture [39]). Last, some *sub-symbolic* mechanisms (without an explicit representation of the world) for regulation, often inspired by biology (*metabolism*, *emotions*, *motivation*, *adaptation*, see, e.g., [64]) can also be incorporated to agents.

Reflecting on the evolution of action selection, Les Gasser proposed in 1998 as one of the fundamental concepts of agent programming the concept of *structured persistent action*, in which the agent is *autonomously* and *persistently* trying to *accomplish something*, independently of the way it is programmed [30]. In standard procedural programming, the programmer explicitly controls the attempts, while the concept of structured persistent action abstracts and *encapsulates* such a mechanism. More precisely, the designer provides the description of the objective or *criteria for success*, as well as in general a collection of *methods* and *recipes*, that the agent will select and control autonomously. Note that some similar mechanisms have already been proposed, for instance *declarative* programming and *backtrack* in logic programming languages such as Prolog, or the general concept of *search*. But, in our opinion, the concept of structured persistent action represents in an interesting way the *encapsulation* of: a notion of *choice*, *informations*¹⁰, an *iterative control structure* (of type *repeat until*), and proper *resources* (own process or thread). In addition, we consider the interaction of the agent with its environment to ensure some *feedback* over its actions and choices (e.g., through some *reinforcement* learning mechanism). Last, we may observe that the *selection* (and therefore the choice) of the *action* takes place at *the moment of the action* by the agent and not at *the moment of the programming* of the agent. Therefore, the concept of agent is situated within the quest for “*ever late binding*”.

Table 1, inspired by [42], summarizes our analysis and Figure 1 illustrates it within our proposed frame of reference.

¹⁰Some informations about the possible choices of actions related to the *domain* in which the agent acts. Such information can be *symbolic* (*beliefs*, *models*, *plans*...) or not, depending on the choice of agent *architecture* and of *representation* of the world.

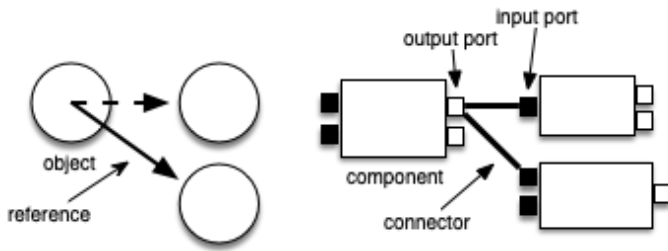

Figure 2: Objects coupling versus components coupling

4 Coupling Flexibility

The modeling of the *coupling* between software entities is a fundamental aspect for the structuring of the software. It actually covers several *facets*:

- *structure*: the *architectural* concepts (e.g., *references*, *connectors*...) for the *structural coupling* between software entities;
- *communication*: the *modes of communication* between software entities, characterized mainly by: the mode for the *designation* of the receiver, the mode for *data transfer*, and the mode for *temporal coupling*.

4.1 Structural Coupling

The question of the *structural coupling* between software entities has been initially addressed by the notion of *reference* to an entity, through some means for identifying it (*identifier*). Therefore, one may *designate* a software entity¹¹, in order to *use* it and to *communicate* its reference to other entities. This model, simple but effective and general, survived with object-oriented programming languages.

For instance, an object A references an object B, and thus will be able to send requests to B. In practice, the internal representation (implementation) of A includes a variable whose value is the identifier of object B. Changing a reference is easy, by just changing the value of the variable, for instance to the identifier of a third object C. However, we can observe that this modification can be done only *internally* to object A, the only one authorized to access its private data (following the *encapsulation* principle).

A serious limitation occurs when we want to *extend* a reference, for instance so that A refers *both* to B and to C (see the left part of Figure 2). Since a variable has only *one* value, this cannot be expressed directly. It is therefore necessary to *introduce* some data structure (a *collection*, e.g., a list), containing B and C. The message sending instruction must also be *modified*, by introducing an *iterator* on the collection. Overall, this implies the *modification* of the *internal representation* of object A (in other words, to *reimplement* it), whereas it is only a question of *extending* the reference and the coupling, initially from A to B, into from A to B *and* C.

The concept of *software component*¹² brings some notable improvement to this problem by *externalizing* the references, describing them as explicit *output interfaces*. Therefore, a component regains some *symmetry* at the level of *interfaces* between *input interfaces*¹³ and *output interfaces*¹⁴.

Coupling thus becomes *explicit*, reified (i.e. coupling is made into first class entities, the *connectors*) and *external* (to the software entities). Previous example is therefore achieved by the simple addition of a connector, as illustrated in the right part of Figure 2.

Note that a component can have *multiple interfaces* (input or/and output interfaces). To be able to identify them individually, an *identifier*, usually named a *port*, is associated to each interface. This is an important difference with an object which has only *one identifier* and *entry point*. An interesting consequence is that components are *compositional*. That is to say that a composition of several components is equivalent¹⁵ to a component with the corresponding union of input ports and output ports. Otherwise, objects are *not* directly

¹¹Simple data in early programming languages, *functions* in functional programming languages, *objects* in object-oriented programming languages. . .

¹²For a more complete analysis of the characteristics of software components and a comparison between different component models, please see, e.g., [20] or/and [37].

¹³which are traditional for procedures and objects.

¹⁴Alternatively named, respectively, *provided interfaces* and *required interfaces*.

¹⁵Actually, we must distinguish between *functional composition*, which is a simple assembly of components, and *structural composition*, which *encapsulates* a functional composition and identifies it as a new component, often referred to as a *composite component*. [20] analyzes their respective binding techniques, named *horizontal binding* and *vertical binding*. We believe that the concept of structural composition is important [53], as it provides *encapsulation* and *hierarchy*, which both proved to be useful to control complexity. However, only a minority of component models support composite components (e.g., Fractal [15] and MALEVA [14], but not JavaBeans [59] nor CORBA Component Model (CCM) [45]).

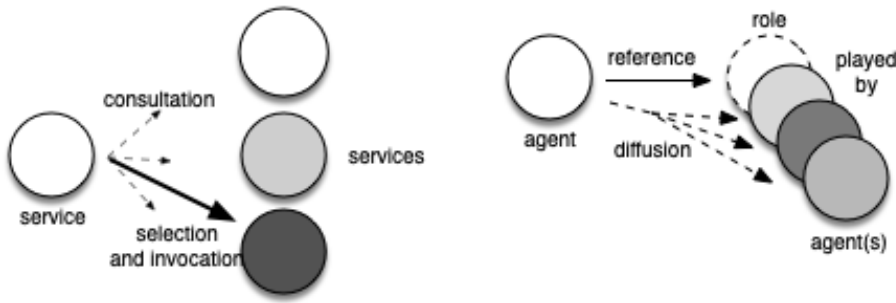

Figure 3: Services coupling and agents coupling

compositional: a composition of several objects is *not* immediately equivalent to an object, as it has more than one entry point.

Therefore, components provide an explicit *architectural* vision¹⁶. *Architecture description languages* (ADL) [54] are dedicated to the specification of the *architecture* of an application and they are indeed very different from standard programming languages. Informations about the *typing* of component interfaces are used to verify correctness of the assembly, i.e. the conformity between the interfaces which are brought in relation. Different types of connectors are usually considered and correspond to different *architectural styles* (e.g. *layered*, *pipes and filters*, *broadcast of events*. . . [54]) and their associated communication protocols. Connectors can also represent *non-functional properties* (such as *distribution*, *quality of service*, etc.) and therefore have their own *semantics* [3].

In order to express not only specifications about the types of data (*typing* information) but also about the *behavior* of components, notions of *contracts* have been proposed. For instance, [5] considers four successive levels of contracts: *syntactic*, *behavioral*, *synchronization*, and *quality of service*. Depending on the case, they can be *guaranteed*, *verified* or *negotiated*. The syntactic level is based on a type system. The behavioral level is usually based on *assertions* (the three main types being: pre-conditions, postconditions, and invariants). But, compared to the use of assertions within a program, the idea of contracts is to specify them in a *modular* way and *visible* through the interfaces of a component, in order to be able to specify properties that can engage more than one software entity [38].

The concept of *service* of *service-oriented architectures architectures* (SOA)¹⁷ extends coupling with *dynamism*, and moreover *autonomy*, via *discovery* and *dynamic selection* of other services (as shown in the left part of Figure 3). Coupling between entities is therefore no longer only managed by the designer of the application, but by the entities themselves, i.e., through *self-organization*. For instance, an electronic travel agency service, looking for services to perform subtasks (e.g., flight reservation, hotels, etc.), will thus be able to *identify*, *select*¹⁸, and *contract* sub-services. Therefore, services are subject to more or less elaborate descriptions, which are made available (*published*), e.g., through directory of services, similar to telephone numbers yellow pages. For web services, UDDI (Universal Description, Discovery and Integration) and WSDL (Web Services Description Language) standards [18] specify, respectively, directories and descriptions of services.

Multi-agent systems further extend dynamism and autonomy by trading some *syntactic* coupling (following some *typing* discipline) for some *semantic* coupling, based on *knowledge* (via abstractions such as: *task*, *plan* and *intention*) and some *social organization of work* (via abstractions such as: *organization*, *role*, *norm* and *negotiation*).

An *organization* specifies the different *roles* constituting it (e.g., roles of *producer*, *consumer* and *broker*) and their *relationships* (e.g., *dependency* and *hierarchy*). A *role* can be *played* by one or more agents and the same agent can also possibly play more than one role simultaneously. Note that an agent referencing a role subsumes a reference to all the agents *fulfilling* (at the time of the interaction) this role¹⁹ (see the right part of Figure 3).

Two important capacities of an organization are its *dynamism* and its *autonomy* (*self-organization* and *self-reorganization*). Some dynamic reorganization can be triggered: in a *top-down* manner, e.g., the reorganization of a robotic football team²⁰ according to a more defensive strategy on the initiative of the coach [34]; or in a *bottom-up* manner, with the dynamic formation (and then dissolution) of a micro-organization of type “one-two” on the initiative of some player agent [21]. Examples of abstract models of organizations are AGR [25] and MOISE+ [34].

As for services, multi-agent systems also often use various mechanisms for putting agents into relation: by

¹⁶The notion of *software architectures* [54] of an application focuses on the logic of the *coupling* between the components, independently of their internal implementation.

¹⁷Including in particular web services [18].

¹⁸In general, according to various criteria (e.g., availability, price, flexibility. . .).

¹⁹This mechanism of *abstract role designation* of the receiver will be analyzed in Section 4.2.1.

²⁰As in the RoboCup contest [35].

some intermediary agents, *directory* agents, or *facilitator* agents guided by the content of the message (e.g., in KQML [26]); or by some *selecting* and *contracting* mechanism, as, e.g., the *contract net protocol* [57]²¹.

To conclude, note that the software architectures and components communities started to support automatic reconfiguration, e.g., for nomadic applications [22]. But the knowledge and social-oriented approach of multi-agent systems is more ambitious, and therefore also more difficult to *verify*. We thus find out some classic *dilemma* between the growing needs for *flexibility*, through some *delegation of initiative*, and the needs to ensure some *guarantees* on the operability of the system.

4.2 Communication Coupling

The expression of the *mode of communication* between software entities includes several important characteristics (sub-facets). We consider here the three main ones:

- how to *designate the receiver(s)*, e.g., *point to point*, *multi-point*, *indexed by content*, via the *environment*...;
- the mode for *data transfer*, e.g., *unidirectional*, *bidirectional* with *value return*, via a *shared space*...;
- the *temporal coupling* (in other words, the way communications are *synchronized*), e.g., *synchronous*, *asynchronous*, with an *anticipated response (future)*, coordinated by a *protocol*...

4.2.1 Designation of the Receiver

The mode of communication between *objects* is fundamentally *point to point*, i.e. *one to one* and with *explicit designation* of the receiver of the message. *Components* introduce *multi-point* communication, as an output of a component can be connected to more than one component. An interesting type of connector is the *event broadcasting* connector, corresponding to the *publish-subscribe* architectural style [54]. It offers an *indirect* and *dynamic* management of connections by the components themselves, through a mechanism of *subscription* of a component to the *event broadcaster*. This type of mechanism²² became widespread (e.g., in applications based on standard objects) although it remains very representative of the concept of connector between software components, defined and manipulated externally to them (as it has been analyzed in Section 4.1).

The *shared spaces* (repositories) architectural style, illustrated by, e.g., *blackboards* and *tuple-spaces* (for instance, the LINDA model [31]), introduces a mode of designation of the receiver totally *implicit*, since it will be *indexed* by the actual *content* of the message. In this model, *active entities* (e.g., processes or agents) can *insert* and *index* structured data within the shared space. Data will be consumed *opportunistically* by active entities looking for the corresponding *data patterns*.

Services, and moreover *multi-agent systems*, generalize mechanisms of *indirect* and *dynamic* designation, through some *contracting protocols* or the consultation of *broker* or *directories* agents (as it has been presented in Section 4.1). Services or agents can therefore dynamically *select* their own *interlocutor*. Some more *implicit* mechanism is the notion of *facilitator*, guided by the *content* of the message [36] (e.g., in KQML [26], to be analyzed in Section 5.2). Another type is the *abstract designation* of a receiver through a *role*, as, e.g., in the AGR (agent group role) *organizational model* [25]. In such role-based models, agents usually designate some *role* (e.g., *midfielder* or *striker*, in a RoboCup football organization), rather than some specific agent, as the receiver of a communication. As a consequence, all the agents *fulfilling* this role *at the time of communication* will receive the information (see the right part of Figure 3).

Last, in certain types of multi-agent systems, in which the *environment* (physical or not)²³ is explicitly modeled, the agents can communicate via the *environment*, though inserting specific data, for example *pheromones* for ant-based algorithms. Note that, moreover, there is a current trend in multi-agent systems for promoting the environment as a *first-class abstraction*²⁴ [62].

4.2.2 Data Transfer

The mode for *data transfer* in object-oriented programming is *bidirectional*, with some *return of value*²⁵. It is inherited from the *procedural* or *functional* call. It corresponds (as we will see in Section 4.2.3) to a *synchronous* call, i.e. with the sender *suspending* its activity while waiting for the *completion* of the processing of the request by the receiver.

²¹It will be discussed in Section 4.2.3 and is illustrated in Figure 5.

²²The subscription criteria and the distribution method may vary, see, e.g., the classification proposed in [23].

²³Algorithms based on *ants* and their *pheromones* can be used as a general meta-heuristic optimization method (see, e.g., [2]), the environment having then no longer relation with a physical reality.

²⁴There is also a similar trend for promoting entities without internal goals and characterized by a function as first-class entities named *artefacts*, which are manipulated (use, selection or construction) by agents [47].

²⁵Unless the programmer explicitly specifies that there is no return value, e.g., in Java using the special data type *void* which represents the *absence of data*.

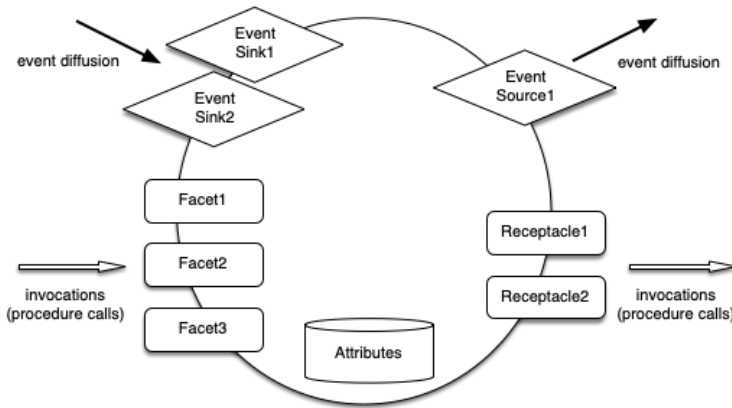

Figure 4: CCM component model

The *actor* model [1] introduces some *unidirectional* (and *asynchronous*, see Section 4.2.3)²⁶. Data transfer is carried out only *one-way* from the sender to the receiver. If the receiver wants to return a value, it must be done *explicitly* by sending another message. Some languages based on actors, as for instance ABCL (Actor-Based Concurrent Language) [63], provide the programmer with a choice between a *one-way asynchronous* message send and a *two-way synchronous* call²⁷. *Component models*, such as CORBA component model (CCM) [45]²⁸ often also propose these two modes of data transfer: *bidirectional* though a *procedure call* (via *input* and *output interfaces*, named *facets* and *receptacles* in CCM), and *unidirectional* though by *event diffusion* (via *event sources* and *sinks*), see Figure 4.

The *shared spaces* architectural style (see the previous paragraph Designation of the Receiver) introduces a mode of data transfer, *indirect*, via some *mediation structure* and the distinction between *production* and *consumption*.

Services are generally based on simple *invocation protocols*, in particular for *web services*. One of the main reasons for the success of web services is likely their easy deployment on top of the widespread web infrastructure and its HTTP protocol. The SOAP protocol [18] (originally the acronym for “Simple Object Access Protocol”) supports both *bidirectional* and *unidirectional* modes.

Multi-agent systems generally offer the *unidirectional* (and *asynchronous*) transfer mode of actors but expressed within more elaborate *agent communication languages* which allow to specify with precision and details the *nature* of the information to be communicated (as it will be presented in Section 5.2).

Last, some possible communication via an *environment* (by adding, removing, or consuming data) represents some *indirect* mode of data transfer.

4.2.3 Temporal Coupling (Synchronization)

The original communication model between software entities (in a *sequential* and *centralized* world) is the *procedural* or *functional call* with *return* of a *value*. The sender activity is *suspended* during the processing of the request by the receiver. A direct transposition into a *concurrent* setting sticks to these principles, with the sender waiting for the call to be completed – this is referred to as *synchronous* transmission. A direct transposition into a *distributed setting* is represented by the RPC (*Remote Procedure Call*), also synchronous.

The actor model [1] introduces an *asynchronous* mode of communication as its foundation, i.e. without waiting for the message to be processed – and before that, to be received – by the receiver. Asynchronous communication is more appropriate to a concurrent or/and distributed setting (due to the potential *latency* of the communication network, this avoids waiting for the delivery of the message to the receiver, as well as its availability to process it). Therefore, the actor model assumes the existence of a *mailbox* for each actor, which will store the messages in the order of the arrival (FIFO type discipline). The actor model thus introduces some *temporal decoupling* between *sending*, *receiving*, *processing start*, and *processing completion* of the message. As indicated in Section 4.2.2, some actor-based languages, such as ABCL, can provide both *one-way asynchronous* and *two-way synchronous* communication (and even other modes, such as the promise/anticipation of the response – often named *future*²⁹ –, which we will not develop here, see [63]). Note that Scala is an example

²⁶This was motivated by the *concurrent* and moreover *distributed* nature of the model, in order to avoid *unnecessary* and *unbounded* waiting for an acknowledgement of data transfer completion.

²⁷Various types of such *actor-based* and *object-oriented concurrent programming* abstractions (action selection, activity, communication and synchronization) have been jointly modeled within the object-oriented framework Actalk [9, 10].

²⁸Note that an example of a more recent component model (also an industry standard), also integrated into a service-oriented architecture, is CSA (Composite Services Architecture) [40]. However, we have chosen here to illustrate our analysis through the CCM model, for its historical and pedagogical value.

²⁹Future is a type of *eager evaluation*, also coined as *wait by necessity* [16], the exact opposite of *lazy evaluation*.

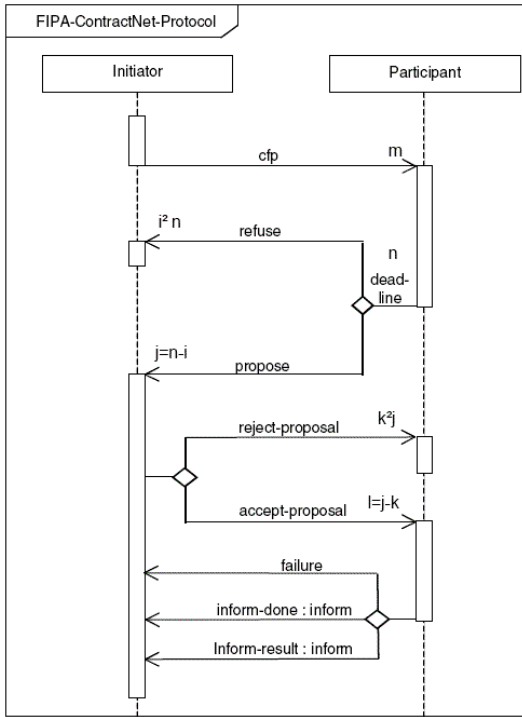

Figure 5: Contract net protocol. Figure reproduced from FIPA Contract Net Interaction Protocol Specification, Foundation for Intelligent Physical Agents, 2002.

of a programming language that integrates *functional*, *object-oriented*, and *actor* programming [43]. Last, for an analysis about the different ways of mapping the object-oriented programming model to *concurrent* and *distributed* programming requirements, please refer, e.g., to [13].

Agent communication languages (ACL), in particular FIPA³⁰ ACL [27], allow the specification of a *protocol* associated with a communication. The *protocol* specifies the *coordination* of valid message exchanges between agents. *Temporal coupling* is therefore expressed in a relatively general manner and with an arbitrary number of messages and agents. Example of families of agent protocols are: *interaction* (e.g., *inform*, *request*...), *coordination* (such as a *simple* or *iterated call for proposals* – see below), *negotiation*, *auction* (e.g., English or Dutch, with an increasing or decreasing initial price). A classic example of a multi-agent protocol is the *call for proposals* (also named the *contract net protocol*). Figure 5 shows the corresponding interaction diagram (as specified by FIPA [27]). Successive phases are: the broadcast of the *initial call* by the *initiator* (also named *contractor*), where *cfp* stands for call for proposals) to the *participants*; various *proposals* (or *refusals*) made by the participants – controlled by some *deadline* (*timeout*) for responding –; the *acceptance* (or *rejection*) of a proposal by the initiator; and finally the communication by the selected participant (also named *sub-contractor*) about the *finalization* and the *result* (or the *failure*) to *process* his proposal.

Web services also offer analog coordination mechanisms, also named *choreography*. The Web Services Choreography Description Language (WS-CDL) has been initially defined with this intent by the W3C³¹, but it has been replaced by the BPEL (Business Process Execution Language) and BPNM (Business Process Model and Notation) standards [41].³²

Table 2 summarizes the evolution of *coupling* according to the 2 main facets: *structure* and *communication*, the latter with its 3 sub-facets: *designation of the receiver(s)*, *data transfer mode*, and *temporal coupling* (*synchronization*). Figure 6 illustrates it within our proposed frame of reference³³.

³⁰FIPA is the acronym for the Foundation for Intelligent Physical Agents, an IEEE Computer Society standards organization that promotes agent-based technology and the interoperability of its standards with other technologies [28].

³¹The World Wide Web Consortium standard [61].

³²We will not detail here the characteristics of services and Web services, which are the subject of standards and numerous technical specifications (see, e.g. [18] and [49], as well as [50] for an agent perspective on web services) because that would be the subject of another article.

³³Note that the coupling flexibility evolution is not completely linear: actors have been proposed *before* components but their respective main focuses are different (respectively, *concurrency* and *architecture*); web services have been proposed *after* multi-agent systems.

<i>Coupling</i>	<i>Objects</i>	<i>Actors</i>	<i>Components</i>	<i>Services</i>	<i>Agents</i>
<i>Structure</i>	Implicit internal <i>(references)</i>	Implicit internal <i>(references)</i>	Explicit external <i>(connectors)</i>	Implicit volatile <i>(invocations)</i>	Implicit external <i>(roles)</i>
<i>Communication</i>					
<i>Receiver(s) designation</i>	Point to point explicit	Point to point explicit	Multi-point explicit or implicit <i>(publish-subscribe)</i>	Multi-point dynamic <i>(discovery and selection)</i>	Multipoint explicit or implicit <i>(role designation)</i>
<i>Data Transfer</i>	Bi-directional <i>(value return)</i> direct	Uni-directional direct	Bi- or uni-directional <i>(events)</i> direct	Bi- or uni-directional	Uni-directional direct or indirect <i>(environment)</i>
<i>Synchronization</i>	Synchronous	Asynchronous	Synchronous or asynchronous	Synchronous or asynchronous	Asynchronous or protocol

Table 2: Coupling nature

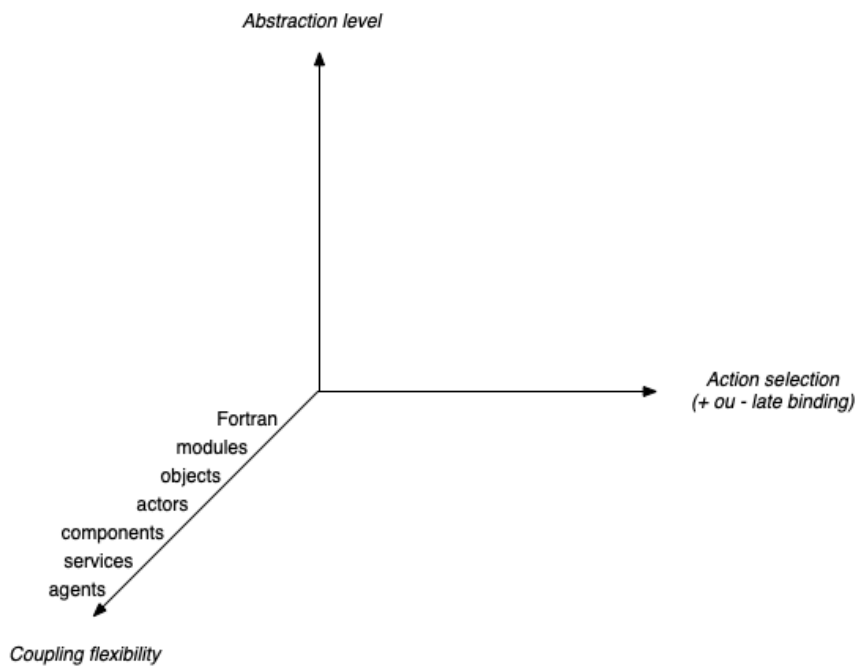

Figure 6: Coupling flexibility evolution

5 Abstraction Level

The history of programming begins with concepts very close to the *machine* (*instructions, integers...*), then progressively identifies some higher level *abstractions* (*procedure, function, data structure, semaphore, process, object, message, component, model...*). The concepts of *agent* and *organization* continue this evolution towards more *abstraction* as well as towards more explicit *knowledge*.

5.1 From Data to Concepts

The transition from *primitive data types* to *abstract data types* allows the modeling and naming of arbitrary *classes* of *objects*. *Object-based programming* introduces some major evolution step, with *objects modeling* and *representing* (*reifying*) *conceptual* or *physical objects* of the *application domain* considered [51]³⁴. In other words, we moved from *data* to *concepts*. *Agents* will extend this evolution with an explicitation of the domain (including human) *knowledge*. *Cognitive agents* introduce the notion of *mental state*, inherited from symbolic artificial intelligence (see, e.g., [55]), with some *symbolic representation* of *cognitive concepts*, such as: *belief, goal, desire, intention...* Furthermore, such *internal knowledge* can be communicated to other (*external*) agents, e.g., communication of *beliefs, plans* or/and *intentions*, in order for agents to *learn* about each others or/and *coordinate* their actions. Agents can also reason about *context*³⁵ for *context-aware* applications such as *ambient intelligence* [60].

The object-oriented discipline of *message sending* also provides some *self-documentation*, as the *subject* and the *request type* are specified *explicitly*. *Agent communication languages* raise further the explicitness of information and knowledge. Indeed, information that had remained *implicit* (and *hidden*) in object-oriented and component-based applications – such as *intention* of communication, *coordination* logic, *plans...* – and remained in the mind of the programmer, become *explicit* and thus better *document* the program. Moreover, this information could also be used by the agents themselves (for example to *coordinate, reason* about communication failures, *replan, reorganize...*).

5.2 Interoperability Languages

Let us look at *interoperability middlewares*, which specify and standardize the *exchange* of information. CORBA object-oriented middleware designed by OMG [44] standardizes, through an *interface description language* (IDL), the *types* of data exchanged. The analogue for agents further refines the way information is exchanged. The IDL of CORBA is substituted³⁶ by a more general *agent communication language* (ACL). In addition to the specific *content* of the message, an ACL communication can specify:

- *performative*: some symbolic designation of the *intention* of the communication (e.g., *inform, deny, recruit...*);
- *content description language*: the *language* used to *describe* the *content*. It can be some *programming language* (e.g., Java) or some *knowledge representation language* (e.g., KIF, or SL [27]);
- *ontology*: the *ontology(s)*³⁷ of the *concepts* referred to by the message (e.g., some standard ontology about transport and tourist services, for some electronic travel agency application);
- *protocol*: the *protocol* used for the communication (e.g., a *call for proposals*, named FIPA-Contract-Net, see Figure 5).

It should be noted that CORBA and ACL do not actually play exactly the same roles [58]. CORBA, through its IDL, provides some standard for specifying the *interfaces* (*signatures*) of objects and components. It also provides *mappings* (named *projections*) of this IDL in different programming languages (e.g., Java, Smalltalk, C++...). Therefore, CORBA can automatically generate *implementation skeletons* for the calling party code and for the called party code, and thus ensure the *translation* and *transfer* of data. An ACL does not offer some standard for specifying interfaces of agents, but offers a general standard for specifying various *properties* of *communication* between agents, which is different. As listed above, ACL standardizes various properties such as *intention, ontology* and *protocols*. The first historically is KQML [26], followed by FIPA ACL [27].

³⁴A review of their successes, failures and prospects is proposed in [52].

³⁵[19] identifies four basic types of *context*: *computational* context (i.e. state of resources of the device and of the network), *user* context (i.e. persons, places, or/and objects), *physical* context (e.g., luminosity, noise, or/and temperature) and *temporal* context (e.g., hour, day, or/and period of the year).

³⁶Actually more than that, as it will be explained in next paragraph.

³⁷I.e. some *representation* of a set of *concepts*, their *properties* and their *relations*.

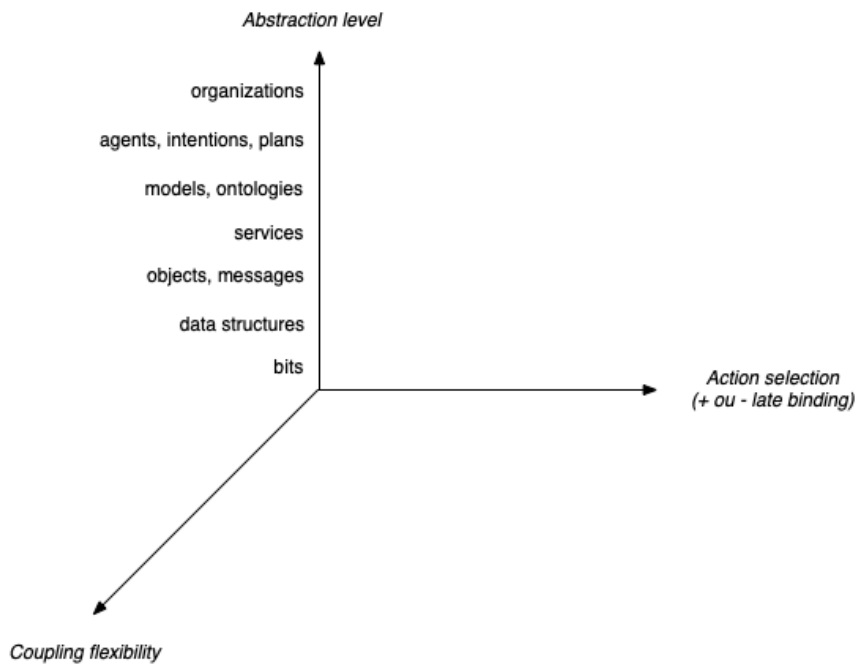

Figure 7: Abstraction level evolution

5.3 Organizational Design

It is also important to highlight the preponderant role of the *design* of systems multi-agent systems. It is guided by the *organization of work* (through concepts such as *organization*, *role*, *dependence*, and *norms*) and by *knowledge* (*mind states* such as *belief* and *intentions*), rather than by the *operational means* for achieving this work, which corresponds to the traditional *procedural* approach of programming (through *data* and *procedures*). Multi-agent *methodologies* (e.g., such as the Cassiopée [21] precursor) often start with some *analysis* of *organizations*, *roles* and their *dependencies*, while considering separately (and later) *implementation* questions (such as: which agents will *fulfill* the roles, depending on what *decomposition* of tasks). Some *agent-oriented design* can then be carried out (implemented) in some multi-agent architecture, or through objects, actors, or/and components, the agent level not always appearing completely at the implementation level³⁸.

Finally, in the *evolution* and the *elevation* of *programming abstractions*, as illustrated in Figure 7, we also need to mention about *model driven engineering*, such as *model driven architecture* (MDA) proposed by the OMG [46]), as a modeling level for the *partial automation* of the construction of applications. Note that this line of research is somehow *orthogonal* to a specific programming model (object-oriented, component-based, agent-oriented. . .). There are efforts to couple multi-agent programming and model engineering, see, e.g., [56].

6 Conclusion

Due to the increasing needs for *auto-adaptation* of future distributed applications (such as, e.g., Internet of Objects), models of software components and software architectures are gradually gaining in terms of *abstraction* as well as in (self) *adaptation* and *reconfiguration* capacities (see, e.g., [58]). They get inspiration from *multi-agent systems* abstractions, while often relying on light-weight infrastructures such as, or inspired by, *web services*. The technology of web services is indeed simpler and lighter to implement and to *deploy* than some distributed component models (such as, e.g., CORBA), as current *web infrastructure* is sufficient. Web services provide the specification of the *coordination* between services (named *choreography*) although it does not yet reach the level of sophistication of multi-agent systems (on this topic, see, e.g., a comparative analysis of web services and agents [50]).

An important stake is therefore be to be able to *integrate* and *reuse*, as much as possible, respective *abstractions* and *experience* from various programming models and communities. However, cultural specificities sometimes lead to some ignorance about respective works. One of the objectives of this analysis is to humbly contribute to clarify various programming abstractions and their respective evolution and articulation and thus

³⁸However, keeping abstractions, such as agents and organizations, as entities *explicitly* represented at the *execution level*, offers of course possibilities of *dynamic manipulation* by the programmer, but above all by the *entities themselves*, thus offering possibilities of *self-adaptation* and *self-organization* (see, e.g., the organizational model MOISE [34]).

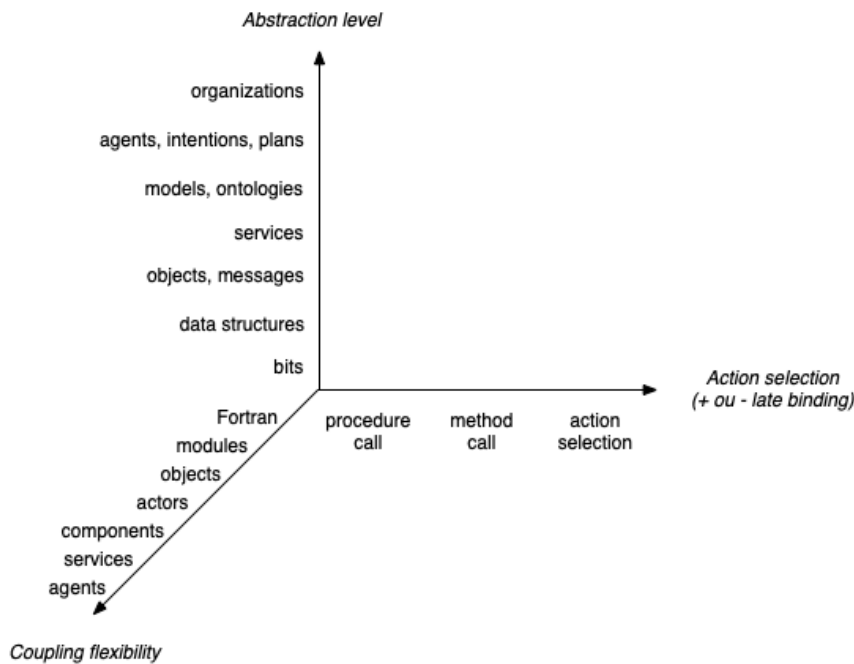

Figure 8: Programming evolution

to favor mutual awareness and possible cross-fertilization³⁹.

Acknowledgements

The premises of this study go back to an interview that we conducted with Les Gasser on the relationship between objects and agents [30], published in a special series on actors and agents [30]. We thank him for his pioneering and fundamental contribution to this reflection and we dedicate this article to his memory.

References

- [1] Agha, G.: *Actors: a Model of Concurrent Computation in Distributed Systems*. Series in Artificial Intelligence. MIT Press (1986)
- [2] Albert, P., Armetta, F., Hassas, S.: *Agents situés : une nouvelle voie pour le développement d'applications industrielles*. In: A.E. Fallah-Seghrouchni, J.P. Briot (eds.) *Technologies des systèmes multi-agents et applications industrielles, IC2*, pp. 101–146. Hermès/Lavoisier (2009)
- [3] Allen, R., Garlan, D.: *Formal connectors*. Research Report CMU-CS-94-115, Department of Computer Science, Carnegie Mellon University, Pittsburgh, PA, USA (1994)
- [4] Bachman, F., Bass, L., Buhman, C., Comella-Dorda, S., Long, F., Robert, J., Seacord, R., Wallnau, K.: *Volume II: Technical concepts of component-based software engineering*. Technical Report CMU/SEI-2000-TR-008 & ESC-TR-2000-007, Software Engineering Institute, Carnegie Mellon, Pittsburgh, PA, USA (2000)
- [5] Beugnard, A., Jézéquel, J.M., Plouzeau, N., Watkins, D.: *Making components contract aware*. *IEEE Computer* **32**(7), 38–45 (1999)
- [6] Boissier, O.: (editor) *Composants et systèmes multi-agents*. *L'Objet* **12**(4) (2006)
- [7] Bordini, R., Dastani, M., Dix, J., Seghrouchni, A.E.F.: *Multi-Agent Programming: Languages, Platforms and Applications*. International Book Series on Multiagent Systems, Artificial Societies and Simulated Organizations. Springer (2005)

³⁹Last section of the original paper [11] identifies various potential *mutual cross contributions* between software components and multi-agent systems: *from agents to components*, e.g., by using mapping and negotiation techniques to assist the *assemblage* of components; and *from components to agent(s)*, e.g., to structure and modularize its *architecture*.

- [8] Bordini, R., Dastani, M., Dix, J., Seghrouchni, A.E.F., Gomez-Sanz, J., Leite, J., O'Hare, G., Pokahr, A., Ricci, A.: A survey of programming languages and platforms for multi-agent systems. *Informatica* **30**(1), 33–44 (2006)
- [9] Briot, J.P.: Modélisation et classification de langages de programmation concurrente à objets : l'expérience Actalk. In: Actes du Colloque Langages et Modèles à Objets (LMO 94), pp. 153–165. INRIA/IMAG/PRC-IA, Grenoble, France (1994)
- [10] Briot, J.P.: An experiment in classification and specialization of synchronization schemes. In: K. Futatsugi, S. Matsuoka (eds.) *Object Technologies for Advanced Software (ISOTAS 96)*, no. 1049 in LNCS, pp. 227–249. Springer, Kanazawa, Japan (1996)
- [11] Briot, J.P.: Composants et agents : évolution de la programmation et analyse comparative. *Technique et Science Informatiques (TSI)* **33**(1-2), 85–115 (2014)
- [12] Briot, J.P., Demazeau, Y.: *Principes et architecture des systèmes multi-agents*. IC2. Hermès/Lavoisier (2001)
- [13] Briot, J.P., Guerraoui, R., Löhr, K.P.: Concurrency and distribution in object-oriented programming. *Computing Surveys* **30**(3), 291–329 (1998)
- [14] Briot, J.P., Meurisse, T., Peschanski, F.: Une expérience de conception et de composition de comportements d'agents à l'aide de composants. *L'Objet* **12**(4), 11–41 (2006). Special issue on Composants et systèmes multi-agents
- [15] Bruneton, E., Coupaye, T., Leclerc, M., Quéma, V., Stefani, J.B.: An open component model and its support in Java. In: 7th International Symposium on Component-Based Software Engineering, no. 3054 in LNCS, pp. 7–22. Springer (2004)
- [16] Caromel, D.: Toward a method of object-oriented concurrent programming. *Communications of the ACM (CACM)* **36**(9), 90–102 (1993)
- [17] Castagna, G.: Covariance and contravariance: Conflict without a cause. *ACM Transactions on Programming Languages and Systems (TOPLAS)* **17**, 431–447 (1995)
- [18] Chauvet, J.M.: *Services Web avec SOAP, WSDL, UDDI, et XML*. Eyrolles (2002)
- [19] Chen, G., Kotz, D.: A survey of context-aware mobile computing research. Technical Report TR2000-381, Department of Computer Science, Dartmouth College, Hanover, NH, USA (2000)
- [20] Crnković, I., Sentilles, S., Vulgarakis, A., Chaudron, M.R.V.: A classification framework for software component models. *IEEE Transactions on Software Engineering* **37**(5), 593–615 (2011)
- [21] Drogoul, A., Collinot, A.: Applying an agent-oriented methodology to the design of artificial organisations: a case study in robotic soccer. *Journal of Autonomous Agents and Multi-Agent Systems (JAAMAS)* **1**(1), 113–129 (1998)
- [22] Dubus, J., Merle, P.: Vers l'auto-adaptabilité des architectures logicielles dans les environnements ouverts distribués. In: M. Ouassalah, F. Oquendo (eds.) *1ère Conférence francophone sur les Architectures Logicielles (CAL 2006)*. Hermès/Lavoisier, Nantes, France (2006)
- [23] Eugster, P., Felber, P., Guerraoui, R., Kermarrec, A.M.: The many faces of publish/subscribe. *ACM Computing Surveys* **35**(2), 114–131 (2003)
- [24] Ferber, J.: *Les Systèmes Multi-Agent – Vers une Intelligence Collective*. InterEditions (1995)
- [25] Ferber, J., Gutknecht, O.: A meta-model for the analysis and design of organizations in multi-agent systems. In: 3rd International Conference on Multi-Agent Systems (ICMAS 98), pp. 128–135. IEEE, Paris, France (1998)
- [26] Finin, T., Labrou, Y., Mayfield, J.: KQML as an agent communication language. In: J. Bradshaw (ed.) *Software Agents*, pp. 291–316. MIT-Press (1997)
- [27] FIPA: Agent Communication Language Specifications (accessed: 13/08/2021). <http://www.fipa.org/repository/aclspecs.html>
- [28] FIPA: Foundation for Intelligent Physical Agents (accessed: 13/08/2021). <http://www.fipa.org/>

- [29] Gasser, L., Briot, J.P.: Object-based concurrent programming and distributed artificial intelligence. In: N.M. Avouris, L. Gasser (eds.) *Distributed Artificial Intelligence: Theory and Praxis*, pp. 81–107. Kluwer (1992)
- [30] Gasser, L., Briot, J.P.: Agents and concurrent objects. *IEEE Concurrency* **6**(4), 74–81 (1998). Interview of Les Gasser by Jean-Pierre Briot
- [31] Gelernter, D., Carrierro, D.: Coordination languages and their significance. *Communications of the ACM* **35**(2) (1992)
- [32] Georgeff, M., Pell, B., Pollack, M., Tambe, M., Wooldridge, M.: The belief-desire-intention model of agency. In: *5th International Workshop on Intelligent Agents V: Agent Theories, Architectures, and Languages (ATAL'98)*, no. 1555 in LNCS, pp. 1–10. Springer (1999)
- [33] Ghezzi, C., Picco, G.: An outlook on software engineering for modern distributed systems. In: *Monterey Workshop on Radical Approaches to Software Engineering*. Venezia, Italy (2002)
- [34] Hübner, J.F., Sichman, J.S., Boissier, O.: Developing organised multiagent systems using the MOISE+ model: programming issues at the system and agent levels. *International Journal of Agent-Oriented Software Engineering (IJAOSE)* **1**(3–4), 370–395 (2007)
- [35] RoboCup Federation Inc: RoboCup (accessed: 13/08/2021). <https://www.robocup.org/>
- [36] Kafura, D., Briot, J.P.: Introduction to actors and agents. *IEEE Concurrency* **6**(2), 24–29 (1998)
- [37] Lau, K.K., Wang, Z.: Software component models. *IEEE Transactions on Software Engineering* **33**(10), 709–724 (2007)
- [38] Meyer, B.: Applying design by contract. *IEEE Computer* **25**(10), 40–51 (1992)
- [39] Müller, J.P., Pischel, M.: The agent architecture InterRRaP: Concept and application. Technical Report RR-93-26, DFKI, Saarbrücken, Germany (1993)
- [40] OASIS: Open composite services architecture (CSA). Tech. rep., OASIS (Organization for the Advancement of Structured Information Standards), <http://www.oasis-openca.org> (accessed: 13/08/2021)
- [41] OASIS: Web services business process execution language (BPEL). Tech. rep., OASIS (Organization for the Advancement of Structured Information Standards), <http://bpel.xml.org> (accessed: 13/08/2021)
- [42] Odell, J.: Objects and agents compared. *Journal of Object Technology (JOT)* **1**(1) (2002)
- [43] Odersky, M., Spoon, L., Venners, B.: *Programming in Scala*. Artima (2010)
- [44] OMG: Common object request broker architecture (CORBA). Tech. rep., Object Management Group (OMG), <http://www.omg.org/corba/> (accessed: 13/08/2021)
- [45] OMG: Corba component model (CCM). Tech. rep., Object Management Group (OMG), <http://www.omg.org/technology/documents/formal/components.htm> (accessed: 13/08/2021)
- [46] OMG: Model driven architecture (MDA). Tech. rep., Object Management Group (OMG), <http://www.omg.org/mda/> (accessed: 13/08/2021)
- [47] Omicini, A., Ricci, A., Viroli, M.: Artifacts in the A&A meta-model for multi-agent systems. *Journal of Autonomous Agents and Multi-Agent Systems (JAAMAS)* **17**(3), 432–456 (2008)
- [48] Oussalah, M.: *Ingénierie des composants – Concepts, techniques et outils*. Vuibert (2005)
- [49] Papazoglou, M.: *Web Services & SOA, Principles and Technology, Second Edition*. Pearson (2012)
- [50] Payne, T.: Web services from an agent perspective. *IEEE Intelligent Systems* **23**(2), 12–14 (2008)
- [51] Perrot, J.F.: Objets, classes et héritage : Définitions. In: R. Ducournau, J. Euzenat, G. Masini, A. Napoli (eds.) *Langages et modèles à objets – État des recherches et perspectives*, Collection Didactique, pp. 3–31. INRIA (1998)
- [52] Perrot, J.F., Briot, J.P.: Introduction. *L'Objet* **10**(4), 11–16 (2004). Numéro spécial : Des octets aux modèles – Vingt ans après, où en sont les objets ?
- [53] Peschanski, F., Meurisse, T., Briot, J.P.: Les composants logiciels : évolution technologique ou nouveau paradigme ? In: *Conférence Objets, Composants, Modèles (OCM 2000)*, pp. 53–65. Nantes (2000)

- [54] Shaw, M., Garlan, D.: *Software Architectures – Perspective on an Emerging Discipline*. Prentice Hall (1996)
- [55] Shoham, Y.: Agent oriented programming. *Artificial Intelligence* **60**(1), 51–92 (1993)
- [56] Silva, V., Choren, R., Lucena, C.: Using UML 2.0 activity diagram to model agent plans and actions. In: *International Conference on Autonomous Agents and Multi-Agent Systems (AAMAS 2005)*. Utrecht, The Netherlands (2005)
- [57] Smith, R.: The contract net protocol: High-level communication and control in a distributed problem solver. *IEEE Transactions on Computers* **29**(12), 1104–1113 (1980)
- [58] van Splunter, S., Wijngaards, N., Brazier, F., Richards, D.: Automated component-based configuration: Promises and fallacies. In: *AISB 2004 Convention 4th Symposium on Adaptive Agents and Multi-Agent Systems (AAMAS-4)*, pp. 130–145. Leeds, UK (2004)
- [59] Sun: Javabeans specification. Tech. rep., Sun Microsystems Inc., <http://java.sun.com/products/javabeans/> (2006)
- [60] Viterbo, J., Mazuel, L., Charif, Y., Endler, M., Sabouret, N., Breitman, K., Seghrouchni, A.E.F., Briot, J.P.: Managing distributed and heterogeneous context for ambient intelligence. In: W. Dargie (ed.) *Context-Aware Self Managing Systems*, CRC Studies in Informatics, chap. 4, pp. 79–128. Chapman & Hall (2009)
- [61] W3C: World Wide Web Consortium (accessed: 13/08/2021). <https://www.w3.org/>
- [62] Weyns, D., Parunak, H.V.D., Michel, F., Holvoet, T., Ferber, J.: Environments for multiagent systems – state-of-the-art and research challenges. In: D. Weyns, H.V.D. Parunak, F. Michel (eds.) *Environments for Multi-Agent Systems – First International Workshop, E4MAS 2004*, New York, NY, July 19, 2004, Revised Selected Papers, no. 3374 in LNAI, pp. 1–47. Springer (2005)
- [63] Yonezawa, A., Briot, J.P., Shibayama, E.: Object-oriented concurrent programming in ABCL/1. *Sigplan Notices* **21**(11), 258–268 (1986). Special Issue. *Proceedings of the Conference on Object-Oriented Programming Systems, Languages and Applications (OOPSLA 86)*, Portland OR, USA
- [64] Ziemke, T., Balkenius, C., Hallam, J. (eds.): *From Animals to Animats 12 – 12th International Conference on Simulation of Adaptive Behavior, SAB 2012*, Odense, Denmark, August 2012, Proceedings. No. 7426 in LNAI. Springer (2012)